

MOUNTING AND INSTRUCTION MANUAL

DTS 4150.grandmaster DTS 4160.grandmaster

Network – Time Server and Master Clock



Important Note:

This Manual is applicable for Firmware version **V1.21.x** (released August 2022) and newer. For older firmware versions please use the User-Manual BE-801214.14 and .10.

Certification of the Producer

STANDARDS

The DTS 4160.grandmaster was developed and produced in accordance with the EU Guidelines:

2014 / 30 / EU	EMC
2014 / 35 / EU	LVD
2011 / 65 / EU	RoHS
1907 / 2006	REACH
2012/19/EU	WEEE



References to the Instruction Manual

1. The information in this Instruction Manual can be changed at any time without notice. The current version is available for download on www.mobatime.com.
2. The device software is continuously being optimized and supplemented with new options. For this reason, the newest software version can be obtained from the Mobatime website.
3. This Instruction Manual has been composed with the utmost care, in order to explain all details in respect of the operation of the product. Should you, nevertheless, have questions or discover errors in this Manual, please contact us.
3. We do not answer for direct or indirect damages, which could occur, when using this Manual.
4. Please read the instructions carefully and only start setting-up the product, after you have correctly understood all the information for the installation and operation.
5. The installation must only be carried out by skilled staff.
6. It is prohibited to reproduce, to store in a computer system or to transfer this publication in a way or another, even part of it. The copyright remains with all the rights with BÜRK MOBATIME GmbH, D-78026 VS-Schwenningen and MOSER-BAER AG – CH 3454 Sumiswald / SWITZERLAND.

Overview

1	Safety	6
2	Maintenance	9
3	General Information: Introduction.....	10
4	Displays	14
5	Installation	17
6	Operation.....	18
7	Updates	77
8	Time administration	83
9	SNMP	96
10	Redundant Power supply	100

Appendix

A	Connection diagrams.....	101
B	Time zone table	111
C	Alarm list.....	113
D	Troubleshooting	115
E	Serial Telegrams.....	116
F	Copyright Notice	121
G	Technical data	122
H	DTS4160.grandmaster i.....	127
I	Index.....	128
J	Connection table (to fill in)	131

Table of contents

1	Safety	6	6.5.15	GNSS settings	52
1.1	Safety instructions	6	6.5.16	GNSS-DCF settings (GNSS-DCF Input)	53
1.2	Symbols and Signal Words used in this Instruction Manual	6	6.5.17	E1 settings (E1 Input)	54
1.3	Intended Use	6	6.5.18	F-IN settings (Frequency Input)	54
1.4	Observe operating safety!	7	6.5.19	Alarms	54
1.5	Consider the installation site!	7	6.5.20	Alarm relay	55
1.6	Please observe the electromagnetic compatibility!	7	6.5.21	Alarm mask	56
1.7	Network security	7	6.5.22	E-mail	57
1.8	Pay attention to the instructions for the connection of the power supply	8	6.5.23	SNMP traps	59
2	Maintenance	9	6.5.24	General settings	61
2.1	Troubleshooting: Repairs	9	6.5.25	Network	62
2.2	Cleaning	9	6.5.26	Link aggregation LAG	66
2.3	Disposing	9	6.5.27	IPv4 static routing	67
3	General Information: Introduction	10	6.5.28	VLAN configuration	68
3.1	Scope of Delivery	10	6.5.29	Services (network services FTP, telnet, SSH...)	69
3.2	Technical Data	10	6.5.30	SNMP	70
3.3	Device Description in this Manual	10	6.5.31	SNMP V1 / V2c	71
3.4	Introduction	10	6.5.32	SNMP V3	71
3.5	Device types	11	6.5.33	Time zone selection	74
3.6	DTS Distributed Time System	12	6.6	Maintenance menu	75
3.7	MOBA-NMS - Network Management System	13	7	Updates	77
4	Displays	14	7.1	Updating images with MOBA-NMS	77
4.1	LED displays front side	14	7.2	Updating images with FTP	77
4.2	LED indication back side	14	7.3	Updating applications or configurations with FTP	78
4.3	Display	16	7.4	Updating images via USB	78
5	Installation	17	7.5	Updating applications or configurations via USB	79
5.1	Connections	17	7.6	FTP connection	80
5.2	Chassis Ground	17	7.7	SFTP connection	80
5.3	Boot procedure of the DTS 4160.grandmaster	17	7.8	SCP connection	81
5.4	Initial configuration	17	7.9	Save Configuration externally	81
5.5	Firmware	17	7.10	Copying Telegram files to the DTS 4160.grandmaster	82
5.6	Basic settings (factory settings)	17	8	Time administration	83
6	Operation	18	8.1	Concept of time administration	83
6.1	General	18	8.2	Synchronization process & diagram	84
6.1.1	Serial connection	18	8.3	Time acceptance	86
6.1.2	Telnet	18	8.4	Stratum handling	87
6.1.3	SSH	18	8.5	Source change example situation	88
6.1.4	Menu structure	19	8.6	Time server	88
6.2	MOBA-NMS operation	20	8.7	Time accuracy, time-keeping	88
6.3	Main menu	21	8.8	Leap second	89
6.4	Status menu	21	8.8.1	Introduction to the leap second	89
6.4.1	Time status information	23	8.8.2	Leap second handling by the DTS 4150 and DTS 4160:	89
6.4.2	Time source information	25	8.8.3	Leap second alert notification on DTS 4150 and DTS 4160 outputs	90
6.4.3	Network diagnostic	26	8.8.4	Leap second correction mode	90
6.4.4	PTP information	27	8.8.5	Leap second status indication	90
6.5	Configuration menu	28	8.9	NTP Authentication	91
6.5.1	Outputs	29	8.9.1	NTP symmetric keys	91
6.5.2	DCF – output	30	8.9.2	NTP Autokey	92
6.5.3	Pulse / Frequency output / 10 MHz output	30	8.10	PTP	92
6.5.4	Serial interface	31	8.11	Synchronous Ethernet (SyncE)	93
6.5.5	IRIG / AFNOR / DCF-FSK Output	33	8.12	E1	93
6.5.6	E1 signals	34	8.13	NTP (as time source)	93
6.5.7	NTP slave clocks / time zone server	34	8.14	Oscillator	93
6.5.8	Time handling	37	8.15	Redundant operation of 2 DTS 4150 or 4160.grandmaster	94
6.5.9	Time source settings	38	8.16	Logfile Synchronization status	95
6.5.10	Time adjustment settings	40	9	SNMP	96
6.5.11	Manual time set / Leap second	41	9.1	General	96
6.5.12	Redundant operation settings	42	9.2	Device configuration with SNMP	97
6.5.13	NTP server settings	42	9.3	DTS subagent SNMP notification	97
6.5.14	PTP Configurations	48	9.3.1	Startup [dts4160StartUp]	97
			9.3.2	Shutdown [dts4160Shutdown]	97

9.3.3	Status changed [dts4160StatusChanged].....	98
9.3.4	Configuration changed [dts4160ConfigChanged].....	98
9.3.5	Alive Notification [dts4160Alive].....	99
9.3.6	Alarm Notification [dts4160Alarm].....	99
10	Redundant Power supply	100

APPENDIX

A	Connection diagrams	101
A.1	Front connections.....	101
A.2	Connections (rear view)	102
A.3	Installation instruction GPS antenna	105
A.3.1	Positioning and assembly of the antenna and EMP protector	105
A.3.2	Installation of the lightning protection (EMP protector).....	105
A.3.3	Distance between antenna and DTS 4160	106
A.3.4	Inline Amplifier.....	106
A.4	Plug-in spring terminals.....	110
B	Time zone table	111
C	Alarm list	113
D	Troubleshooting	115
E	Serial Telegrams (<i>only DTS 4160</i>)	116
E.1	General	116
E.2	Syntax of the telegram configuration file ...	117
F	Copyright Notice	121
G	Technical data	122
H	DTS4160.grandmaster i	127
I	Index	128
J	Connection table (to fill in)	131

1 Safety

1.1 Safety instructions

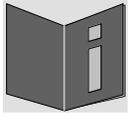

Read this chapter and the entire instruction manual carefully and follow all instructions listed. This is your assurance for dependable operations and a long life of the device.

Keep this instruction manual in a safe place to have it handy every time you need it.

1.2 Symbols and Signal Words used in this Instruction Manual

	Danger! Please observe this safety message to avoid electrical shock! There is danger to life!
	Warning! Please observe this safety message to avoid bodily harm and injuries!
	Caution! Please observe this safety message to avoid damages to property and devices!
	Notice! Additional information for the use of the device.
	Important information in the Manual! This information must be followed!

1.3 Intended Use

The **DTS 4150.grandmaster** and **DTS 4160.grandmaster** are a primary reference clocks (PRC), Grandmaster and Timeserver for the high accurate synchronization of various equipment's and for the use in large network environments.

They receive time information from GPS. An intelligent time management ensures lasting high accuracy by continuously compensating oscillator drift and aging.

With 4 network ports, they can operate as NTP server and with 3 ports as PTP grandmaster in different networks.

Only the DTS 4160 provides 1 output lines for E1 / 2.048MHz, 1 IRIG/AFNOR line (available as analog and digital output), 1 configurable frequency output as well as 2 serial interfaces for the output of time telegrams.

To maintain a redundant time source, two DTS 4150 or 4160 can be linked together over an optical link.

For additional functions, see the device descriptions in chapter 3.

The devices are designed for 19" racks and intended to be installed in a 19" cabinet. Operate the device only in installed condition and with all connectors plugged in.



Caution!

1.4 Observe operating safety!

- Never open the housing of the device! This could cause an electric short or even a fire, which would damage your device. Do not modify your device!
- The device is not intended for use by persons (including children) with limited physical, sensory, or mental capacities or a lack of experience and/or knowledge.
- Keep packaging such as plastic films away from children. There is the risk of suffocation if misused.



Caution!

1.5 Consider the installation site!

- To avoid any operating problems, keep the device away from moisture and avoid dust, heat, and direct sunlight. Do not use the device outdoors.
- The device is designed for 19" racks and should only be operated installed in a 19" cabinet.



Danger! Make sure

that you wait before using the device after any transport until the device has reached the ambient air temperature. Great fluctuations in temperature or humidity may lead to moisture within the device caused by condensation, which can cause a short.



Caution!

1.6 Please observe the electromagnetic compatibility!

- This device complies with the requirements of the EMC and the Low-voltage Directive.



Caution!

1.7 Network security

- The default password should be changed during commissioning.
- A reset of the password to default through hardware is not possible. Using MOBA-NMS the password can be modified. In case an access via MOBA-NMS is not possible, support effort will be needed or the device has to be sent back to the factory.
- Use encrypted services (SSH, SCP, SFTP)
- All unused services shall be deactivated: FTP, Telnet,...
- Refer to our Security Guidelines TE-801312 (<https://www.mobatime.com/resource/276/dts-4160-grandmaster> in ab "Further Documentation").

1.8 Pay attention to the instructions for the connection of the power supply

The connections are described in appendix "A Connection diagrams".



Danger! Absolutely pay attention:

Mounting, installation, commissioning and repairs of electrical devices must only be carried out by a licensed electrician. While the national installation regulations must be adhered.



For each power supply connection (**Mains**) / (**DC In**) two fuses of 10A (13A) slow has to be provided (in both lines).

The used fuses for the DC- and battery supply have to be approved for DC.

Each power supply connection (**Mains**) / (**DC In**) needs to be realized with an all-pole disconnection device, which is installed near to the device mentioned in this manual, which is clearly labeled and good accessible.

Before working on a device or on the electrical installations the corresponding circuits have to be switched off and secured against uncontrolled power on.

In case more than one supply voltage is used, all of them have to be disconnected before starting any maintenance work.

2 Maintenance

2.1 Troubleshooting: Repairs

Please read carefully Appendix D Troubleshooting if your device does not work properly.

If you cannot rectify the problems, contact your supplier from whom you have purchased the device.

Any repairs must be carried out at the manufacturer's plant.

Disconnect the power supply immediately and contact your supplier if ...

- liquid has entered your device.
- the device does not properly work and you cannot rectify this problem yourself.

2.2 Cleaning

- Please make sure that the device remains clean especially in the area of the connections, the control elements, and the display elements.
- Clean your device with a damp cloth only.
- Do not use solvents, caustic, or gaseous cleaning substances.

2.3 Disposing



Device

At the end of its lifecycle, do not dispose of your device in the regular household rubbish. Return your device to your supplier who will dispose of it correctly.



Packaging

Your device is packaged to protect it from damages during transport.

Packaging is made of materials that can be disposed of in an environmentally friendly manner and properly recycled.

3 General Information: Introduction

3.1 Scope of Delivery

Please check your delivery for completeness and notify your supplier within 14 days upon receipt of the shipment if it is incomplete.

The package you received contains:

- **DTS 4150.grandmaster and DTS 4160.grandmaster**
 - Mounting set for rack mounting consisting of:
 - 4 pcs nuts for 19" housing
 - 4 screws M6 for the nuts
 - 4 plastic discs for screws M6
- **Connector set DTS 4150.grandmaster**
 - 1 * plug 3-pole black for power supply
 - 1 * spring terminal 6-pole orange
 - 2 * spring terminal 2-pole orange
- **Connector set DTS 4160.grandmaster**
 - 1 * plug 3-pole black for power supply
 - 1 * spring terminal 6-pole orange
 - 3 * spring terminal 2-pole orange
 - 1 * spring terminal 5-pole orange
 - 1 * spring terminal 2x5-pole orange
- 2 pcs mounting tools with spring terminals

3.2 Technical Data

See Appendix "G Technical data".

3.3 Device Description in this Manual

This instruction manual is intended for the time servers **DTS 4150.grandmaster**, **DTS 4160.grandmaster** and **DTS 4160.grandmaster i** (see Appendix H).

DTS 4160 with special galvanically separated redundant 24 – 68 VDC inputs:
DTS 4160c.grandmaster 2x eDC (see chapters 3.5, 10 and Appendix G)

DTS 4160.grandmaster and DTS 4160.grandmaster i do have exactly the same functions, except from the E1 outputs which are special for the (i) version (see Appendix H).

Notice: All chapters with **no** special remark below the title "**Only applicable for DTS 4160.grandmaster**" are valid for DTS 4150 and DTS 4160, even in the text picture is only mentioned DTS 4160!



3.4 Introduction

The **DTS 4150.grandmaster** and **DTS 4160.grandmaster** are primary reference clocks (PRCs), Grandmaster and Timeserver for high accurate synchronization of various equipment's and for the use in large network environments. They can be synchronized over GNSS, PTP, High Precision DCF and E1. Equipped with a Rubidium Oscillator (only DTS 4160) it has very high holdover accuracy, ITU-T G.811 can be achieved.

They are a PTP grandmaster according to IEEE 1588-2019 for the synchronization of PTP clients.

They are equipped with up to 4 network ports (IPv4/IPv6) for time distribution, synchronization or configuration.

It can be used as a master clock for NTP slave clocks, synchronizes via NTP unicast or multicast and with time zone information.

In addition, the DTS 4160 provides one line for E1 / 2.048MHz, IRIG/AFNOR (available as analogue and digital output), two configurable frequency outputs as well as two serial interfaces for the output of time telegrams.

To maintain a redundant time source, two DTS 4150 or DTS 4160 can be connected over an optical link.

DTS 4150 and DTS 4160 can synchronize master clocks or other equipment with DCF.

DTS 4150 and DTS 4160 can send both e-mails and SNMP traps for alerting purposes.

Using MOBA-NMS and SNMP, the DTS 4150 and DTS 4160 can be fully operated and its configuration and system status can be requested.

3.5 Device types

Model	Oscillator type	Holdover	Product no.
DTS 4150.grandmaster	TCXO	see appendix G	125600

Type	Model	Oscillator type	Compatibility according to oscillator	Product no.
A	DTS 4160a.grandmaster	OCXO	G813	122031
B	DTS 4160b.grandmaster	DOCXO	G812	122032
C	DTS 4160c.grandmaster	Rubidium	G811	122033

Type	Model	Oscillator type	Compatibility according to oscillator	Product no.
A	DTS 4160a.grandmaster i	OCXO	G813	125283
C	DTS 4160c.grandmaster i	Rubidium	G811	125290

Type	Model	Oscillator type	Compatibility according to oscillator	Product no.
C	DTS 4160c.grandmaster 2x eDC	Rubidium	G811	132315

3.6 DTS Distributed Time System

DTS (Distributed Time System) is a system developed by Moser-Baer AG to distribute time information to decentralized master clocks, slave clock lines and time servers or send synchronization signals to any other equipment. For communication, standard LAN (Ethernet) is used. The DTS can be centrally operated and monitored.

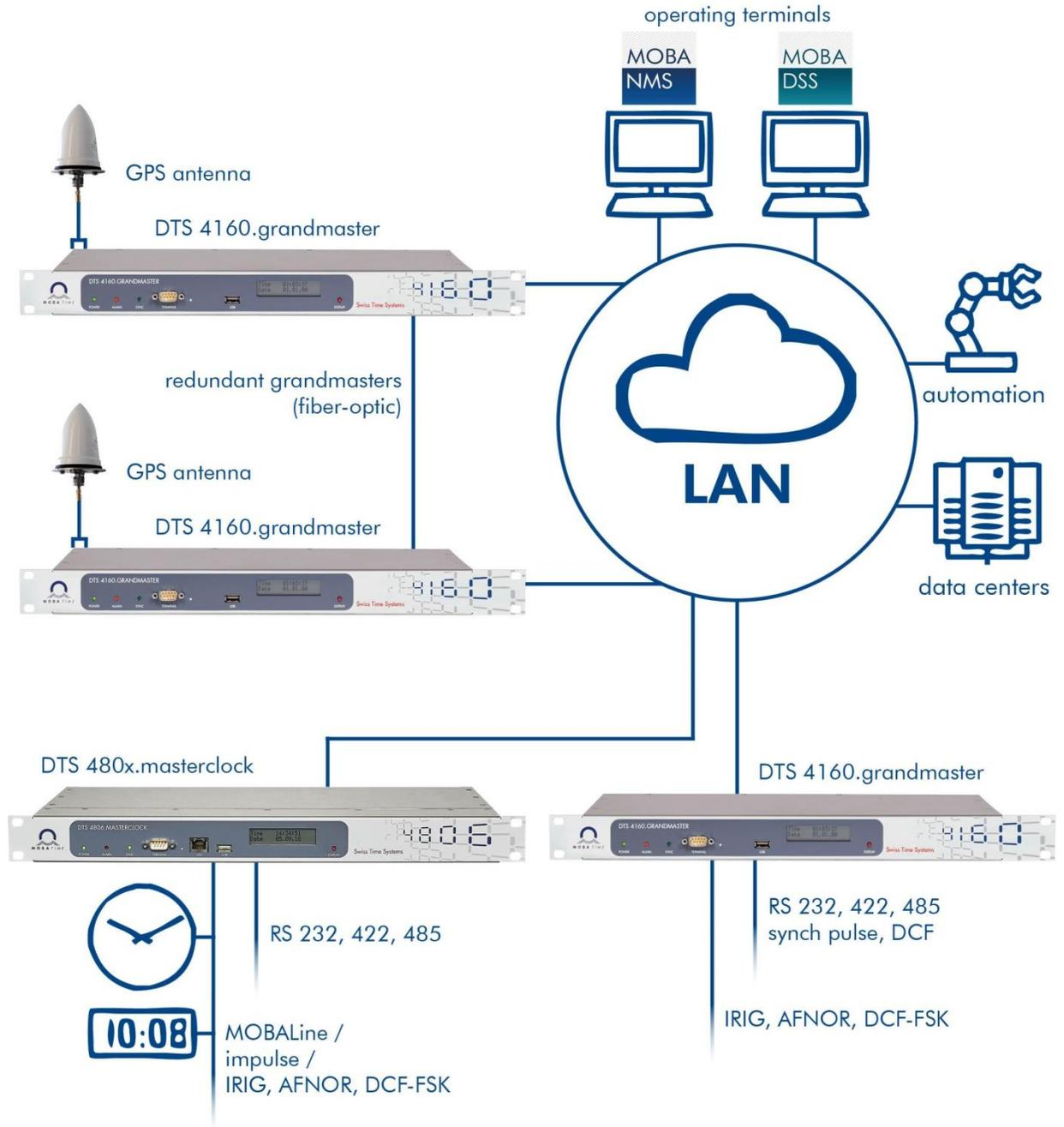

3.7 MOBA-NMS - Network Management System

MOBA-NMS is software used for central management and inquiry of state and alarm information. It supports DTS devices as well as all MOBATime analog and digital network clocks and can handle a network with more than 1000 devices. This software provides extensive functions for the configuration, installation, back-up / recovery etc. especially for DTS devices.

Due to the DTS concept, MOBA-NMS can be installed multiple times in one network. With different user rights on the device and software level, the configuration abilities of different users can be set as required.

For DTS devices, all communication is conducted over SNMP V3. The SFTP protocol is used for broadcasting files.

Overview of MOBA-NMS functions for DTS devices and network clocks:

- automatic device scan over multicast or IP range
- device management using user-defined device groups
- intuitive user interface with input check for the device configuration
- status / alarm request and display on the device group level
- device firmware update for one or several devices (parallel)
- support for device commands, e. g. reset, restart etc.
- back-up / recovery of DTS devices
- transfer of the whole DTS configuration to another device
- user management with different access rights
- monitor for NTP and time zone packages
- editor for time zone files
- online help

More information are available in MOBA-NMS User-Manual BE-801225.

4 Displays

4.1 LED displays front side

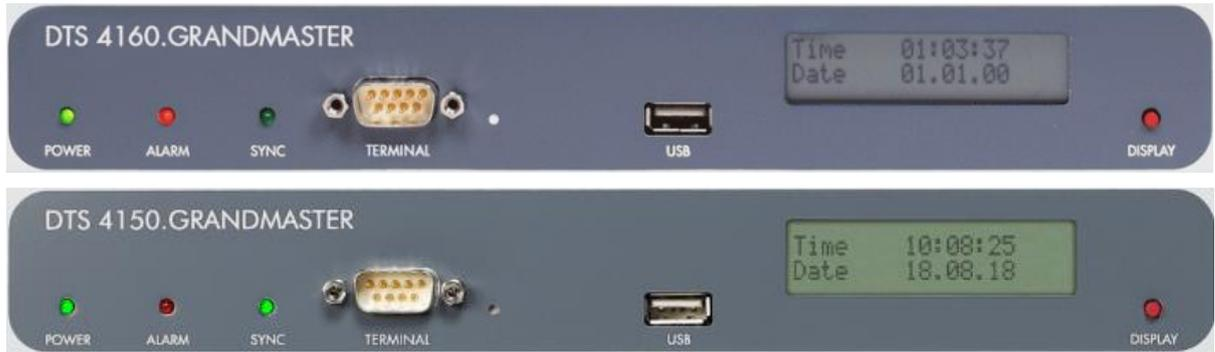

Description	Color	Status	Description
Power	Green	On	Mains or DC power supply is OK
		Off	No power supply
Alarm	Red	On	The alarm relay signalizes an alarm
		Off	No active alarms
Sync	Green	On	DTS 4160 is synchronized to the time source. Time source can also be the internal oscillator.
		Off	Never synchronized to a time source (at startup). No output signals available.

Off when alarm "Time source fail stratum" occurs.
See chapter 6.5.9 Time source settings, menu 4: "Stratum limit for synchalarm".
The delay for this alarm is defined in menu 5: "Stratum TO (0-16) source fail".

4.2 LED indication back side

DTS 4160:

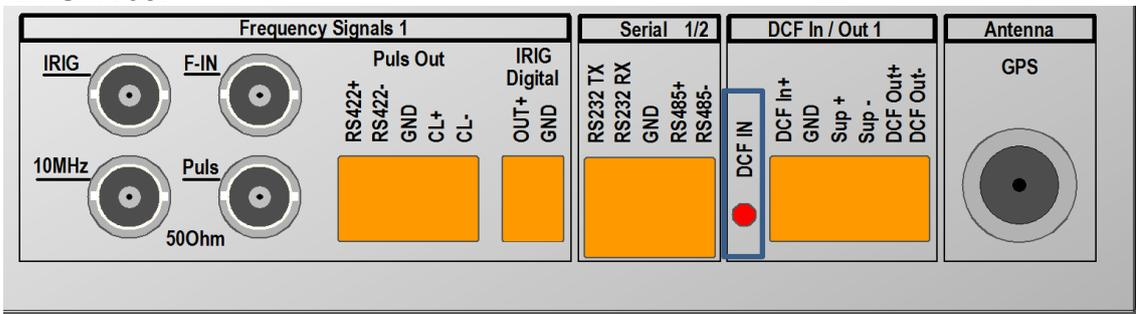

DTS 4150:



Description	Color	Status	Description
DCF in	red	Blinking	Blinking when pos. edge received on the input.

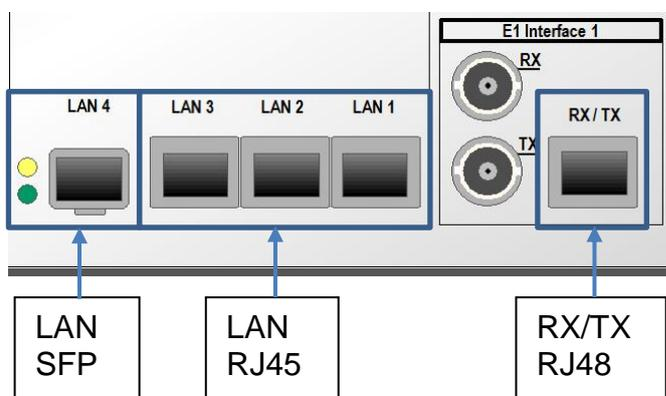

Description	Color	Status	Description
LAN SFP			
control lamps:			
Upper	Yellow	Blinking Off	Network activity No activity
Lower	Green	On Off	Link 100 Mbit & 1 Gbit No Link
LAN RJ45			
control lamps:			
Left	Green	On Off	Link 100 Mbit & 1 Gbit No Link
Right	Yellow	Blinking Off	Network activity No activity

4.3 Display

Display showing the current status of the DTS 4160.

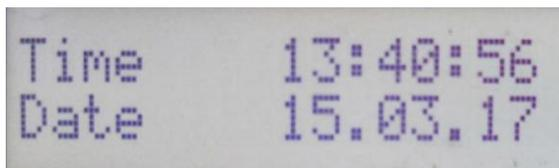

Display of:

- Time, date
- Current time source
- Stratum of the DTS 4160, status: Master / Slave
- Software version
- IPv4 address LAN 1
- IPv4 address LAN 2
- IPv4 address LAN 3
- IPv6 address LAN 1
- IPv6 address LAN 2
- IPv6 address LAN 3
- Power Supply 1
- Power Supply 2
- Alarm summary
- Current alarms

The display can be operated by means of the corresponding “Display“ button:

First press the button briefly:	Switch on the background light
Other buttons to press briefly:	Scroll through all displays
Press button longer (>3 sec):	Change to default display (time and date)

The display changes after approx. 3 min without pressing the button for the default display and the background light goes off.

5 Installation

5.1 Connections

The connections are specified in Appendix "A Connection diagrams". Only connect the designated devices to the various inputs and outputs.

5.2 Chassis Ground

In order to guarantee correct operation of the DTS 4160 the chassis must be connected to an earth ground. The earth ground connection is specified in Appendix "A Connection diagrams".

5.3 Boot procedure of the DTS 4160.grandmaster

The normal booting time of the DTS 4160 is approx. 180 sec. with pre-set IP or with DHCP. The booting procedure of the operating system is displayed on the serial console. After that, the text "starting" appears on the display (during the booting procedure the display is dark and empty).

The display "starting" remains until the time of output to the lines. The duration, depending on the configuration, is 15-45 sec.

5.4 Initial configuration

Per default, all LAN interface for configuration (LAN1 – LAN3) are preconfigured with DHCP on. After booting in a network with DHCP server, the received IP address can be displayed. If no DHCP server is available in the network, initial configuration has to be done via serial terminal.

5.5 Firmware

It is recommended to install the current firmware on your device prior to the definite commissioning. The current firmware can be found under: <https://www.mobatime.com/resource/276/dts-4160-grandmaster> in tab "Firmware".

5.6 Basic settings (factory settings)

To evaluate the basic settings you can follow the steps below:

- Save current configuration of your device, e.g. to USB thumb drive, see chapter 7.9
- Set device to factory settings: Enter menu, 3 Maintenance – 6 Restore configuration (default MOBA)
- Save factory configuration to a new USB thumb drive and you can analyze the **dts41xx.conf** file
- Restore the original configuration you have saved at the beginning, see chapter 7.5

6 Operation

6.1 General

Operation occurs via a terminal menu or SNMP. SNMP operation is explained in chapter “9 SNMP”. Operation with the terminal menu takes place either via Telnet or SSH. After a connection has been set up, the login screen is displayed:



```
DTS4160 login:
```

To start the menu, you must be logged in as user *dtS*. The standard password is *dtS*. (Changing the password → see chapter “6.5.24 General settings”).

Only one menu can be open at any time. The first menu started has priority. The menu is automatically closed after 15 min. without operation, and any open connection via Telnet or SSH is interrupted.

6.1.1 Serial connection

38400 Bauds, 8 data bits, no parity, 1 stop bit.

Windows 7, 8, 10: Putty

Linux: Minicom

Switch off Xon/Xoff and hardware handshake.

After establishing the serial connection, the menu can be initialized with ENTER. When rebooting, the boot process will be displayed on the serial console.



Warning: The serial connection should always be disconnected before switching off the operating PC (exit terminal program or pull out the RS232 plug).

6.1.2 Telnet

Windows 7, 8, 10: e.g. with Putty
Username: *dtS*
Standard password: *dtS*

Linux: Start console and enter “*telnet [IP-address]*”

6.1.3 SSH

Windows 7, 8, 10: e.g. with Putty
Username: *dtS*
Standard password: *dtS*

Linux: Start console and enter “*ssh dtS @[IP address]*”

6.1.4 Menu structure

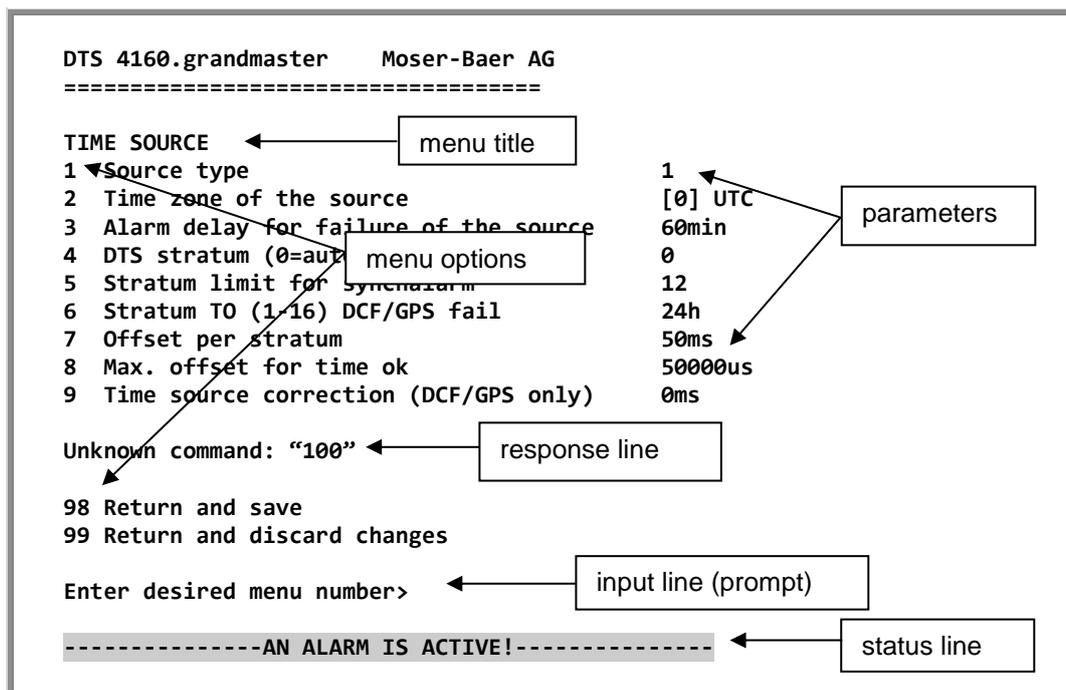

The current menu is always displayed in the **menu title**. The **menu options** show all the selectable menu functions. Provided the menu item is not a further menu, the set **parameters** are displayed. Error messages (e.g. invalid entries) or additional information to the selected menu items are displayed in the **response line**. The **input line** shows the current input values or options possible. The **status line** only appears, when an information has to be displayed, e.g. "An alarm is active".

All entries must be completed with ENTER (Return) (e.g. also ESC).

The menu window can always be exited with *Ctrl-C* (incl. termination of the Telnet and SSH connection).

The desired menu can be selected with the relevant number.

The numbers 98 and 99 are always used identically:

- With 98, the settings entered are saved and the menu exited. Depending on the change, the DTS 4160, or only partial functions, are rebooted.
- With 99, all changes to the menu are reversed and the menu exited. In the menus where data cannot be saved (command 98), the menu is only exited with 99, but any changes are not saved.

The current menu is updated, without any further entry, with ENTER.

6.2 MOBA-NMS operation

For the configuration of DTS devices via GUI, MOBA-NMS (see chapter „3.7 MOBA-NMS - Network Management System“) can be used. All configuration possibilities are subordinated in different configuration pages (called „tabs“). These tabs are connected to the terminal menu and designated accordingly. Example: The terminal menu „Configuration → Alarms“ can be found in MOBA-NMS under the tab „Alarms“.

Configuration example of a DTS 4160.grandmaster:

The screenshot displays the MOBA-NMS GUI for a DTS 4160 Grandmaster. The main content area is divided into several sections:

- List of active alarms:** (No active alarms)
- Network:**
 - General:** Host name: dts4160, Domain name: mobatime.com, VLAN1 ID: Disabled, VLAN2 ID: Disabled, MAC address: 20:b0:f7:03:95:e2, Link status: Up, Link mode: 100 Mbit/s, full duplex (link OK, auto negotiation), LAG status: Disabled, PTP Config: Disabled, SyncE: Disabled.
 - IPv4:** DHCP: On, IP address 1: 172.16.26.126, Subnet mask 1: 255.255.240.0, Gateway 1: 172.16.18.1, IP address 2: None, Subnet mask 2: None, Gateway 2: 172.16.18.1, DNS server: 10.240.0.7.
 - IPv6:** Auto conf: Off, DHCP V6: Off, Link local IP: fe80::22b0:f7ff:fe03:95e2/64, Global IP 1: None, Global IP 2: None, Gateway: None.
- GNSS Source:** GNSS OK, can be used as time source.
- NTP state:** Show NTP status details...
- Redundant Operation:** Link State: MASTER, Last time received from Master as Slave: Jun 1, 2017 12:05:45 PM, Last measured offset to Master as Slave: 181 ns, Status: No leap second detected, Date of next leap second: None, Direction of next leap second: None.
- Power:** Supply mode: Single, Power supply 1 [V]: 0.0, Power supply 2 [V]: 0.0.
- Time, time state:** Internal time (UTC): Jun 2, 2017 5:24:30 AM, Stratum and status: 1 MASTER, Time source: GPS, Offset to source [ns]: -12, Last time info from source: Jun 2, 2017 5:22:18 AM, Jitter of the source [ns]: 0, Quality of the source: 100%, Oscillator lock state: Locked.
- Leap second:** Status: No leap second detected, Source of leap second: None, Date of next leap second: None, Direction of next leap second: None.

At the bottom, a navigation bar contains tabs for Overview, Network Overview, Outputs, Time handling, Alarms, PTP configurations, VLAN configurations, Network, SNMP, General, and Services. A callout box points to the 'Alarms' tab with the text 'configuration pages (tabs)'.

configuration pages
(tabs)

For further details on the general MOBA-NMS operation, check the integrated online help (menu „Help → Show help“).

Important: To enable the communication between MOBA-NMS and the DTS devices, SNMP must be activated! Set terminal menu „Configuration → SNMP → SNMP Mode“ to „on“. SNMP is activated by default.



6.3 Main menu

```
DTS 4160.grandmaster Moser-Baer AG
=====

MAIN SELECTION
1 Status
  (Actual alarms and history, timesource state, version)
2 Configuration
  (Configuration of the outputs, timesources, alarms ...)
3 Maintenance
  (Update, backup ...)

99 Exit DTS menu

Enter desired menu number>
```

Menus:

- Status: Display of various information regarding operation and environment
See chapter "6.4 Status menu"
- Configuration: Configuration of the DTS 4160
See chapter "6.5 Configuration menu"
- Maintenance: Software update, backup and restore
See chapter "6.6 Maintenance menu"

6.4 Status menu

The status menu consists of 2 pages.

Status menu page 1:

```
DTS 4160.grandmaster Moser-Baer AG
=====

CLOCK STATE Page 1/2
1 Alarm state
2 Alarm history
3 Time state
4 Time source
5 GNSS
6 Info network config.
7 Internal state
8 Product information
9 Versions of the software

Press enter for next part, 99 to leave>
```

Path: 1 Status

The sub-menus show various information's about the current operating status:

1. Requesting alarm status, display of all the DTS 4160 active errors.
Display of the DTS 4160 alarms (64) on 4 pages. The ALARM DETAIL menu pages can be scrolled through with ENTER. Active alarms are displayed with a *. The ALARM DETAIL menu page can be exited with 99. All DTS 4160 active alarms are displayed, masking (e-mail, traps and relay) only occurs later.
2. Alarm history display.
Display of the DTS 4160 alarm record, newest alarm first. The ALARM RECORD

menu pages can be scrolled through with ENTER. The ALARM RECORD menu page can be exited with ESC.

Max. length of error report: 240 messages.

3. Current time and status display. See chapter "11 Time status information"
4. Time source information display. See chapter "6.4.2 Time source information"
5. GNSS Information
6. Current network configuration display. With ENTER, a second page can be displayed with network information.
7. DTS 4160 system information display (internal status, regulation voltage of the oscillator..). This information is for support purposes only.
8. Product information like serial number, firmware version etc.
9. All respective software versions of the DTS 4160 components.

Status menu page 2:

```
DTS 4160.grandmaster  Moser-Baer AG
=====

CLOCK STATE                               Page 2/2
11 NTP peer state (ntpq -np)
12 NTP state (ntpq -c r1)
13 Power
14 Network Diagnostic
15 Info PTP

Press enter for next part, 99 to leave>
```

Path: 1 Status → [Enter]

11. Display of information with regard to the internal state of the NTP server.
12. Shows state of the time source for NTP
13. Power supply information (voltage) display.
14. Network diagnostic for ping and routing table information.
15. Display information of all possible PTP connections

6.4.1 Time status information

```

DTS 4160.grandmaster Moser-Baer AG
=====

TIME STATUS INFORMATION                                PAGE 1/2
Internal time of the DTS (local time)                10:11:47 26.01.15
Stratum and state of DTS                             1 MASTER
TAI Offset                                           37
Time source                                           GNSS
  Last time information from source                   09:11:44 26.01.15 UTC
  Offset to source                                   10ns
  Jitter of the source                               1ns
  Quality of the source                              100%

99 Return

Enter desired menu number>

```

Path: 1 Status → 3 Time, time state

- Internal time of the DTS: local time
- Stratum and status of the DTS: current stratum, status: MASTER, SLAVE, not defined
- TAI Offset current TAI offset in seconds (used for PTP)
- Time source: current time source
- Last time info. from source: time of the last information from source
- Offset to source: offset to source (source – system time)
- Jitter of the source: current jitter
- Quality of the source: quality of the source

```

DTS 4160.grandmaster Moser-Baer AG
=====

TIME STATUS INFORMATION                                PAGE 2/2
Leap second information
  Status                                             No leap second detected
  Date of the next leap second                       None
  Adjust direction                                   None
  Leap second source                                 None
  Date of the last implemented leap second           None
Oscillator locked state                             locked

99 Return

Enter desired menu number>

```

Path: 1 Status → 3 Time, time state → enter

- Leap second information: Shows if a leap second is detected and when one is detected on which date it will be and in which direction.
- Oscillator locked state: Only used for type c to show if the rubidium oscillator is stable.

MOBA-NMS: Tab: Overview, Frame: Time, time state

GNSS Source GNSS OK, can be used as time source. Details...	Time, time state Internal time (UTC): Jul 22, 2021, 10:20:04 AM Stratum and status: 1 Not available Time source: GNSS Offset to source [ns]: 4 Last time info from source: Jul 22, 2021, 10:17:18 AM Jitter of the source [ns]: 0 Quality of the source: 100% Oscillator lock state: Locked
NTP state Show NTP status details...	
Time source details Details...	
Redundant Operation Link State: Not available Last time received from Master as Slave: Jan 1, 1970, 12:00:00 AM Last measured offset to Master as Slave: 0 ns Status: No leap second detected Date of next leap second: None Direction of next leap second: None	
Power Supply mode: Single Power supply 1 [V]: 29.1 Power supply 2 [V]: 0.1	Leap second Status: No leap second detected Source of leap second: None Date of next leap second: None Direction of next leap second: None Date of last leap second: None Direction of last leap second: None

Next refresh: 0 min. 17 sec.

Overview **Network Overview** Outputs Time handling Alarms PTP configurations VLAN configurations Network SNMP General, Services

6.4.2 Time source information

All sources overview

```

DTS 4160.grandmaster Moser-Baer AG
=====

TIMESOURCE INFORMATION                                     PAGE 1/8
Source                                                    GNSS-DCF
Configured                                               yes      no
Locked                                                   yes      no
Priority                                                  1       4
Offset [s]                                               0       0
Offset [ns]                                              5       0
Stability [ppb]                                         1       20
Rating                                                   1       3

99 Return

Enter desired menu number>

```

Path: 1 Status → 4 Time source

Source information (GNSS, RED. LINK, PTP, DCF-HQ, 4160: E1, 4150: NTP)

```

DTS 4160.grandmaster Moser-Baer AG
=====

TIMESOURCE INFORMATION                                     GNSS      PAGE 3/8
Priority                                                  1
State: Reachable / Locked                               yes / locked
Last time received                                       09:12:00 08.11.18 (UTC)
Last measured offset                                     0ns
Stability (Deviation)                                   12ppb

Leap status                                             No leap second detected
  Date of next leap second / Adj. direction             None / None

99 Return

Enter desired menu number>

```

Path: 1 Status → 4 Local source → enter (2x – 6x)

For all sources the same information is shown

- Priority: Current source priority
- State: Reachable / Locked A source is reachable if it provides time to DTS on a regular basis. A source is locked, if the time provided is stable.
- Last time received: last time received from source
- Last measured offset last measured offset with source info and type of measurement (only needed for Moser-Baer support).
- Stability (Deviation) Estimation of the current stability in parts-per-billion
- QL (only for E1): The received quality level over E1
- Leap second status: Shows the leap second if it is detected by this source.

6.4.3 Network diagnostic

```
DTS 4160.grandmaster Moser-Baer AG
=====

NETWORK DIAGNOSTIC
1 Ping
2 Routing table

99 Return

Enter desired menu number>
```

Path: 1 Status → 14 Network diagnostic

It is possible to configure a ping command and to show the routing table of the device

Ping

```
DTS 4160.grandmaster Moser-Baer AG
=====

NETWORK PING
1 Select LAN interface(1-4)      1
2 Select IP configuration(1-2)   1
3 Destination IP address        192.168.0.20

5 Execute ping command

99 Return

Enter desired menu number>
```

Path: 1 Status → 14 Network diagnostic → 1 Ping

1. Select LAN interface on which the ping is sent out
2. Select if the IP configuration one or two shall be used
3. Address of from the other device (Ping Destination)
5. Execute Ping command and shows the result in the same window

6.4.4 PTP information

PTP instances

```
DTS 4160.grandmaster Moser-Baer AG
=====

PTP INSTANCE
1 LAN2 IP1
2 LAN2 IP2
3 LAN3 IP1
4 LAN3 IP2
5 LAN4 IP1
6 LAN4 IP2

99 Return

Enter desired menu number>
```

Path: 1 Status → 15 Info PTP

See the status of the running PTP instances. It is possible to configure two IP addresses per LAN interface. When PTP is enabled there is a PTP instance started for both IP addresses. Because of that every LAN interface has a submenu for each possible IP address.

PTP Information of the instance

```
DTS 4160.grandmaster Moser-Baer AG
=====

PTP INFO DEVICE          LAN2 IP1          PAGE 1/3
State                    MASTER
Offset to Master         0ns
PathDelay (E2E)          0ns
PathDelay (P2P)          30ns
ClockClass                6
ClockAccuracy            0x21
TimeSource                0x20

99 Return

Enter desired menu number>
```

Path: 1 Status → 15 Info PTP → 1 LAN2 IP 1

Shows the state of the PTP instance.

Possible values are Master, Slave, Faulty and Unknown

Offset to Master in Nano seconds (only in slave state)

Measured path delay (cable delay). Only in E2E mode and slave state.

Measured peer delay (cable delay). Only in P2P mode. Master and slave both measure the peer delay.

With the clock class and the clock accuracy it is possible to see how the overall quality of the clock is.

Time source shows what source type the device has. In this example 0x20 stands for GPS.

6.5 Configuration menu

```
DTS 4160.grandmaster   Moser-Baer AG
=====

CONFIGURATION
1  Outputs
2  Time handling
3  Alarms
4  General
5  Network
6  VLAN configuration
7  Services (FTP, telnet, SSH)
8  SNMP

99 Return

Enter desired menu number>
```

Path: 2 Configuration

Configuring the DTS 4160 through various submenus:

1. Configuring the outputs (DCF/pulse/frequency, serial interfaces, IRIG/AFNOR/DCF-FSK and NTP slave clock line) See chapter "6.5.1 Outputs"
2. Configuring the time source, time-keeping etc.
See chapter "6.5.8 Time handling"
3. Alarm settings (alarm relay, e-mail, SNMP)
See chapter "6.5.19 Alarms"
4. General settings of the DTS 4160 (language, time zone for alarms and display, password for menu, power supply monitoring...)
See chapter "6.5.24 General settings"
5. Network Settings
See chapter "6.5.25 Network"
6. VLAN configuration
see chapter 6.5.28 VLAN configuration
7. Services (switching network services such as FTP, Telnet, SSH on or off)
See chapter "6.5.29 Services (network services FTP, telnet, SSH...)"
8. SNMP Configuration for GET/PUT.
See chapter "6.5.30 SNMP" (Traps are described in menu '2. Configuration' → '3. Alarms' → '3. Traps'. See also chapter "6.5.23 SNMP traps")

6.5.1 Outputs

Under “Outputs”, settings can be undertaken for the following functions:

```

DTS 4160.grandmaster   Moser-Baer AG
=====

CONFIGURATION OUTPUTS
1 DCF output
2 Pulse / frequency outputs
3 Serial outputs
4 IRIG outputs
5 E1 signals
6 NTP slave clock / time zone server

99 Return

Enter desired menu number>
    
```

Path: 2 Configuration → 1 Outputs

- | | | |
|---------------------------------------|----------------------|---------------------|
| 1 DCF - Output | | → see chapter 6.5.2 |
| 2 Pulse / Frequency outputs | only DTS 4160 | → see chapter 6.5.3 |
| 3 Serial outputs | only DTS 4160 | → see chapter 6.5.4 |
| 4 IRIG / AFNOR / DCF-FSK outputs | only DTS 4160 | → see chapter 6.5.5 |
| 5 E1 signals | only DTS 4160 | → see chapter 6.5.6 |
| 6 NTP slave clocks / time zone server | | → see chapter 6.5.7 |

MOBA-NMS: Tab: Outputs

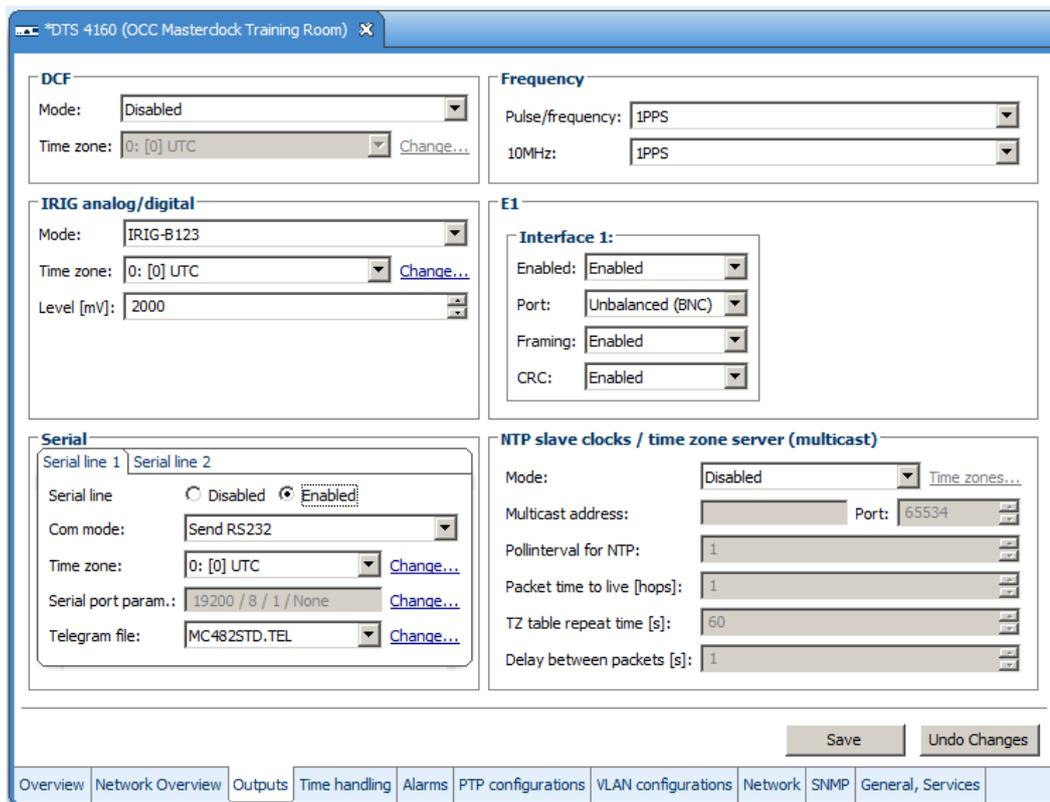

6.5.2 DCF – output

The DTS 4160 is equipped with 1 DCF output line (electrical current loop DCF output).

```
DTS 4160.grandmaster Moser-Baer AG
=====

DCF OUTPUT                                1
1 Mode (0=off, 1=DCF, 2=1PPS)             1
2 Time zone                               [0] UTC

98 Return and save
99 Return and discard changes

Enter desired menu number>
```

Path: 2 Configuration → 1 Outputs → 1 DCF outputs → DCF out 1

1. Select line function: 0 = Off
1 = DCF
2 = 1PPS (1 pulse per second)
2. Select time zone → see chapter 6.5.33 Time zone selection.

6.5.3 Pulse / Frequency output / 10 MHz output

Only applicable for DTS 4160 !

The DTS 4160 is equipped with 2 pulse / frequency interfaces. The signals are available on the BNC connectors Pulse and 10 MHz.

In addition, 1 of the pulse / frequency outputs is available as 1PPS on RS422 output (Pulse Out) and current loop (Pulse Out) output.

```
DTS 4160.grandmaster Moser-Baer AG
=====

PULSE / FREQUENCY OUTPUT                  1
1 Mode                                    1PPS

98 Return and save
99 Return and discard changes

ESC=back
Mode 0=off, 1=10MHz, 2=2.048MHz, 3=1PPS, 4=2Hz>

Enter desired menu number>
```

Path: 2 Configuration → 1 Outputs → 2 pulse / frequency outputs → 1 pulse / frequency out 1

1. Select line function: 0 = Off
1 = 10 MHz output
2 = 2.048 MHz output
3 = 1 pulse per second
4 = 2 Hz

6.5.4 Serial interface

Only applicable for DTS 4160 !

Serial telegram output via RS232, RS422 or RS485.

```
DTS 4160.grandmaster Moser-Baer AG
=====

SERIAL OUTPUT                                1
1 Mode (0=off, 1=on)                          1
2 Time zone                                  [0] UTC
3 Com Mode                                    1
4 Baudrate                                   19200
5 Databit                                    8
6 Stopbit                                    1
7 Parity                                     none
8 Telegram file                             MC482STD.TEL

98 Return and save
99 Return and discard changes

Enter desired menu number>
```

Path: 2 Configuration → 1 Outputs → 3 Serial output → Serial out 1

1. Select mode: Line switched off / on
2. Select time zone → see chapter 6.5.33 Time zone selection.
3. Com mode:
 - 1 = send RS 232 (receive is not enabled)
 - 2 = send and receive RS232
 - 3 = send and receive RS485
 - 4 = send RS 422 (receive is not enabled)
4. Baudrate: 300, 600, 1200, 2400, 4800, 9600, 19200, 38400
5. Data bit: 7 or 8
6. Stop bit: 1 or 2
7. Parity: none, even
8. Selecting telegram file changes to the menu "SELECTION OF FILE"

Notice: To set the parameters, the line type has to be selected first.

Notice: No flow control available.

The description of the telegram function and the telegram file can be found in Appendix E Serial Telegrams.



Selection of the telegram file:

```
DTS 4160.grandmaster Moser-Baer AG
=====

SELECTION OF FILE                               Page 1
00: MC482STD.TEL                               01: MC482UTC.TEL

Enter requested file number

Press enter for next part, ESC to leave>
```

Path: 2 Configuration → 1 Outputs → 3 Serial output → Serial out 1 → 8 Telegram file

The copy procedure of telegram files is explained in chapter "7.10 Copying Telegram files to the DTS".

MOBA-NMS: Frame: Serial, e.g. Interface 1 → click on "Change"

1. To add a new Telegram file, click on "Change"
2. Click on "Upload file..." to choose a new file from PC hard disk.
3. After upload, the new file is listed in the file list and can be selected in drop box after a reload of the device configuration in NMS.

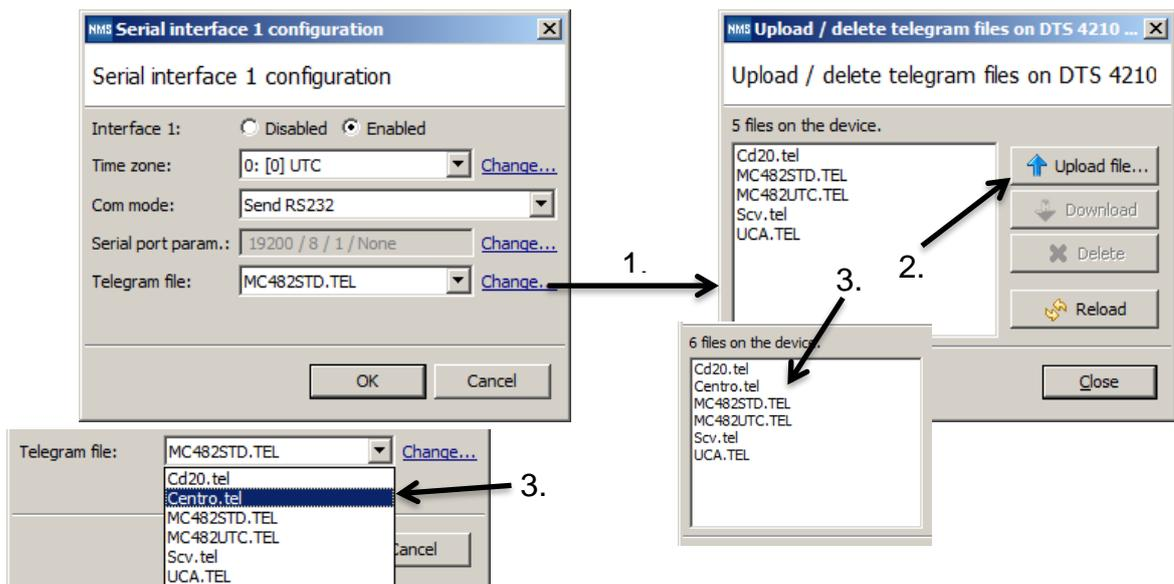

6.5.5 IRIG / AFNOR / DCF-FSK Output

Only applicable for DTS 4160 !

```
DTS 4160.grandmaster Moser-Baer AG
=====

IRIG OUTPUT                               1
1 Mode                                    off
2 Time zone                               [0] UTC
3 Level (~Upp @ Ri=Rl=500hm)             2000mV

98 Return and save
99 Return and discard changes

Enter desired menu number>
```

Path: 2 Configuration → 1 Outputs → 4 IRIG outputs → 1 IRIG out 1

1. Select mode: see picture below
2. Select time zone → see chapter 6.5.33 Time zone selection.
3. Configuration of the output voltage level (2000 – 4000 mV):
The defined voltage corresponds to the expected output amplitude when power matching (impedance matching) with a load of 50 Ohms is fulfilled. The output voltage is not controlled, resp. it is not adjusted in case of a load change.

Selection line mode:

```
DTS 4160.grandmaster Moser-Baer AG
=====

SELECTION IRIG/AFNOR CODE
* 00: off
 01: IRIG-B (B122)
 02 IRIG-B 12h (B122)
 03 IRIG-B DIEM (B122)
 04 IRIG-B123
 05 AFNOR-A (NFS 87-500)
 06 AFNOR-C (NFS 87-500)
 07 DCF-FSK
 08 IRIG-E122 DIEM
 09 IRIG-B126

Enter requested audio code

ESC to leave>
```

Path: 2 Configuration → 1 Outputs → 4 IRIG outputs → 1 IRIG out 1 → 1 Mode

6.5.6 E1 signals

Only applicable for DTS 4160 !

The DTS 4160 is equipped with 1 E1 Interfaces. The E1 signal is available on the BNC (unbalanced) or on the RJ48 (balanced) connector.

```
DTS 4160.grandmaster Moser-Baer AG
=====

E1 OUTPUT                                1
1 Mode (0=off, 1=on)                     1
2 Port                                    unbalanced
3 Framing                                  1
4 CRC (0=off, 1=on)                       1

98 Return and save
99 Return and discard changes

Enter desired menu number>
```

Path: 2 Configuration → 1 Outputs → 5 E1 signals → E1 out 1

1. Mode of E1 signal: 0 = off, 1 = on
2. Port: 0 = unbalanced (BNC), 1 = balanced (RJ48)
3. Framing: 0 = off, 1 = on
4. CRC: 0 = off, 1 = on

6.5.7 NTP slave clocks / time zone server

NTP settings for the operation of Multicast slave clocks on the LAN (Ethernet).

```
DTS 4160.grandmaster Moser-Baer AG
=====

NTP SLAVE CLOCKS AND TIME ZONE SERVER
1 Mode(0=off 1=NTP 2=NTP+TZ 3=TZ 4=TZ poll) 0
2 Multicast address
3 Multicast port 65534
4 Pollinterval for NTP 0
5 Packet time to live (hops) 1
6 Repeat time to send TZ-tables (sec) 60
7 Delay time between packets (sec) 1
8 Configure time zone table

98 Return and save
99 Return and discard changes

Enter desired menu number>
```

DTS 4150: Path: 2 Configuration → 1 Outputs → 2 NTP slave clocks / time zone server

DTS 4160: Path: 2 Configuration → 1 Outputs → 6 NTP slave clocks / time zone server

1. Mode of clock line: 0 = off, 1 = Send NTP multicast, 2 = Send NTP multicast and time zone table, 3 = Send time zone table, 4 = Time zones on request, 5 (only for maintenance) = Send an empty time zone table and return to previous mode.
2. Multicast address for NTP and time zone server: **239.192.54.x**
Group address: x = 1-15 for MOBATIME devices, e.g. NMI, SEN 40.

3. Multicast port for Time zone server (enter an arbitrary value, empty is not allowed! Value e.g.: 65534). The port is also needed for requesting time zone entries (mode 4).
4. Poll-interval for NTP Multicast in $2^{\text{poll-values}}$ in seconds (range: 1 – 16).
E.g. poll-value = 2 → interval: $2^2 = 4$ sec., poll-value = 5 → interval: $2^5 = 32$ sec.
For redundant Multicast time servers see remark next page.
5. Packet time to Live (TTL) for NTP- and time-zone-Multicast-packets in hops.
(Number of Routers in a network to transfer the packets through; for simple network without routing, enter value "1", for 1 Router enter "2").
6. Repeat time to send time zone table: 10 – 86400 sec.
7. Delay time between the sending of the individual time zone entries (one entry per Multicast packet) of the table: 1 – 60 sec.
8. Configuration of individual time zone entries. Displays menu "TIME ZONE TABLE".



Notice: Changes of multicast address, poll interval and TLL lead to a **restart** of the NTP server.



Notice: For the operation of a **multicast** communication (NTP and Time Zone Server) **the configuration of a gateway is required** (see chapter "6.5.25 Network"). The gateway can be set manually or by using DHCP.
If there's no gateway available, it's possible to set the own IP as gateway.



Notice: Redundant Multicast time server:
If two NTP servers in the same network should send NTP with the same Multicast IP address (redundancy), then the first time server has to be configured with a small **pollinterval** (e.g. 2 → 4 sec.) and second time server with a large pollinterval (min. 100 x larger, e.g. 9 → 512 seconds).
As long as the first time server is sending NTP Multicast packets, the packets from second time server are ignored. This configuration is needed, to reach a defined situation for the end devices (the DTS with the more frequently NTP send rate gets higher priority for time reception).

Time zone table for the NTP slave clock line:

```

DTS 4160.Grandmaster Moser-Baer AG
=====

TIME ZONE - TABLE
Zone01: -1 Unknown season      Zone02: -1 Unknown season
Zone03: -1 Unknown season      Zone04: -1 Unknown season
Zone05: -1 Unknown season      Zone06: -1 Unknown season
Zone07: -1 Unknown season      Zone08: -1 Unknown season
Zone09: -1 Unknown season      Zone10: -1 Unknown season
Zone11: -1 Unknown season      Zone12: -1 Unknown season
Zone13: -1 Unknown season      Zone14: -1 Unknown season
Zone15: -1 Unknown season

Enter requested entry

Press enter for next part, 99 to leave>

```

Path: 2 Configuration → 1 Outputs → 5 NTP slave clocks / time zone server → 8 Configure time zone table

Display of all time zone entries (15) of time zone servers for NTP slave clock lines.

Choose a zone number to change selected zone.

Time zone selection → see chapter “6.5.33 Time zone selection“.

Exit page with 99. Save changes with 98 in upper menu page.

MOBA-NMS: Tab: Outputs, Frame: NTP slave clocks / time zone server

1. Time zone server in Unicast mode: Set “Mode” to “Time zone server on req.”
2. Click on “Time zones...” to define the list of time zones, sent to slave clocks.
3. In the list of time zones you can define up to 15 different time zones for slave clocks, e.g. for a World Time Clock.

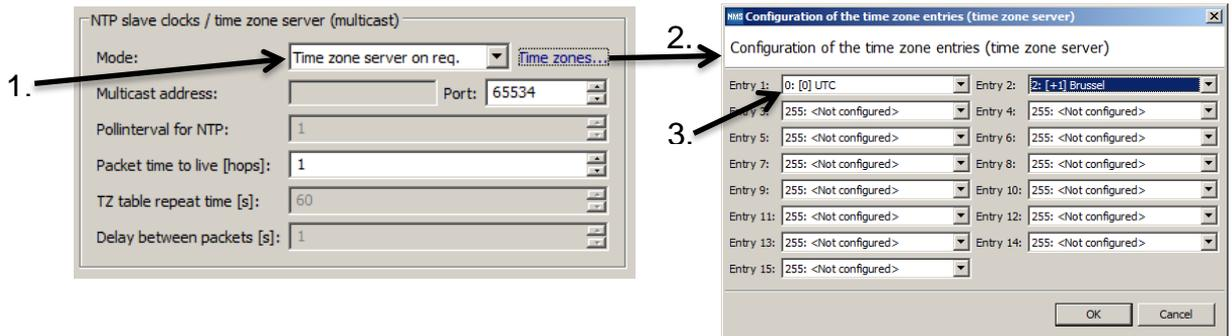

6.5.8 Time handling

Under time handling, settings can be done for the following functions:

- General source settings → see chapter “6.5.9 Time source settings“
- Time adjustment settings → see chapter “6.5.10 Time adjustment“
- Manual time adjustment → see chapter “6.5.11 Manual time set / Leap second“
- Redundant operation → see chapter "6.5.12 Redundant operation settings"
- NTP server settings → see chapter “6.5.13 NTP server settings“
- PTP settings → see chapter “6.5.14 PTP Configuratio“
- GNSS settings → see chapter “6.5.15 GNSS settings“
- DCF settings → see chapter “6.5.16 GNSS-DCF settings (GNSS-DCF Input)“

MOBA-NMS: Tab: Time handling

The screenshot shows the 'Time handling' configuration page for a DTS 4160 device. The interface is divided into several sections:

- Time source priority:** A list of six priorities with dropdown menus. Priority 1 is set to 'GNSS', Priority 2 to 'PTP', Priority 3 to 'Red. link', Priority 4 to 'DCF-HQ', Priority 5 to 'None', and Priority 6 to 'None'. The 'Priority mode' is set to 'Manually'.
- Time source settings:** A panel with several input fields: 'Alarm delay for failure of source [min]: 1', 'Stratum (0=auto, 1-15=fix): 0', 'Stratum limit for synchalarm: 12', 'Stratum timeout (1-16) source fail [h]: 999', 'Stratum change when source fails: Default', and 'Max. offset for time ok [ns]: 250'.
- Time adjustment settings:** A panel with: 'Adjust mode: Follow (Adjust slowly)', 'Max. catch-up speed [ns/s]: 4', 'Synch. only offset (1000-5000000ns, 0=Off): 0', and 'RTC mode: Off'.
- Leap second / Manual time adjustment:** A panel with: 'Leap second mode: None', 'Leap second date: [empty]', 'Set time (UTC): 24.07.2020 13:52:47', and 'Adjust time [ns]: 0'.

At the bottom of the configuration area, there are 'Save' and 'Undo Changes' buttons. Below the configuration area is a navigation bar with tabs: Overview, Network Overview, Outputs, Time handling (selected), Alarms, PTP configurations, VLAN configurations, Network, SNMP, and General, Services.

6.5.9 Time source settings

Time source configuration.

```
DTS 4160.grandmaster Moser-Baer AG
=====

TIME SOURCE
1 Source configuration
2 Alarm delay fail. highest source prio. 1min
3 DTS stratum (0=auto, 1-15=fix) 0
4 Stratum limit for synchalarm 12
5 Stratum TO (1-16) source fail 999h
6 Stratum change source fail default
7 Max. offset for time ok 100 000 000ns
8 Alarm big offset to source 100 000 000ns

98 Return and save
99 Return and discard changes

Enter desired menu number>
```

Path: 2 Configuration → 2 Time handling → 1 General source setting

1. Menu to configure source types and priorities
2. Alarm delay failure highest source priority (minutes):
1min - 2'160min, default = 1
Error message: "Failure loss of time source TO"
3. DTS stratum: 0 = Stratum is automatically calculated according to the time source.
1-15 = Stratum DTS 4160 is set by means of the description in chapter "8.4 Stratum handling"
4. Stratum limit for synchalarm: Limit for alarm "Time source fail stratum" (1-16).
Default value: 12
Description in chapter "8.4 Stratum handling"
5. Stratum TO (Timeout) source fail:
Duration of stratum change from 1 to 16 in the case of time source loss (1-999h),
e.g. 24 hrs → stratum counts up from 1 to 16 within 24 hrs.
Default value: 999h
6. Stratum change source fail: default = Default Stratum change behaviour
immediate = Stratum is decreased by one step
immediate after "failure of time source" has been detected
7. Maximum offset for time source to set valid time in ns at start up.
(0-100'000'000ns). Default: 100'000'000ns
8. Alarm "Time source big offset" is displayed, when offset is bigger than specified value. (0-100'000'000ns). Default: 100'000'000ns

For description of time source see chapter "8 Time administration"

Time Source Priority configuration

```

DTS 4160.grandmaster   Moser-Baer AG
=====

TIME SOURCE PRIORITY
1 Source Priority1      GNSS
2 Source Priority2      NONE
3 Source Priority3      NONE
4 Source Priority4      NONE
5 Source Priority5      NONE
6 Source Priority6      NONE

10 Priority Mode        manual

98 Return and save
99 Return and discard changes

Enter desired menu number>

```

Path: 2 Configuration → 2 Time handling → 1 General source setting → 1 Source configuration

DTS 4150:

(1-5)Source PriorityX 0=NONE, 1=GNSS, 2=Redundant Link, 3=PTP,
4=GNSS-DCF, 7=NTP

DTS 4160:

(1-6)Source PriorityX 0=NONE, 1=GNSS, 2=Redundant Link, 3=PTP,
4=GNSS-DCF, 5=E1, 6=F-IN

10 Priority Mode

0 = auto: In this mode the device makes the priority of the sources and not the user. In this case the rating of the source is the priority.

1 = manual: The configured priorities are used to check which source has to be active.

6.5.10 Time adjustment settings

```

DTS 4160.grandmaster Moser-Baer AG
=====

TIME ADJUSTMENT CONFIGURATION
  Adjust mode (0=follow, 1=set)           0
  Max. catch up speed                    1ns/s
  Time core type (0-255, default 0)      0
  4 Synch. only offset                   0ms
  5 RTC mode                             0

98 Return and save
99 Return and discard changes

Enter desired menu number>

```

Path: 2 Configuration → 2 Time handling → 2 Time adjustment setting

1. Adjust mode: 0=time is slowly adjusted
1=time is set immediately



Notice: This device supports “adjustment” only, therefore parameter is not configurable

2. Maximum catch up speed: Depending on installed Oscillator type:

DTS 4150:

TCXO: 50ns / s

DTS 4160:

A (OCXO): 25ns / s

B (DOCXO): 4ns / s

C (Rubidium): 1ns / s

3. Time core type: Standard=0 (0-255) → unused parameter
4. Synch. only offset: 0=off
1'000-5'000'000ns=Limits as from which time is no longer accepted → Alarm “Synch only diff too large”
5. RTC mode 0=RTC deactivated
1=ON



Important! The RTC mode is used only for test purposes!

RTC behaviour if mode=ON:

- A Valid time source has to be available for RTC first time set
- On startup the RTC is used to set the DTS time.
- As soon as an other source is available the DTS swiches to this source
- A time jump has be expectet on such source switch



Important! For the redundant operation and if **high precision time signal outputs** (E1, PTP, 1PPS,...) are used, the RTC mode should never be switched on!



Important! RTC cannot handle Leap second

For a description of time-keeping see chapter “8 Time administration”

6.5.11 Manual time set / Leap second

```
DTS 4160.grandmaster Moser-Baer AG
=====

MANUAL TIME SET
1 Set time (UTC)
2 Adjust time
3 Leap second mode 0
4 Leap second date (UTC) 00:00:00 01.07.15

98 Return and save
99 Return and discard changes

Enter desired menu number>
```

Path: 2 Configuration → 2 Time handling → 3 Manual time adjustment / leap second

1. Set UTC time in the format "hh:mm:ss DD.MM.YY".
Time is set with ENTER!
2. Correct time in ns (- = backwards). Range: +/-1'000'000'000ns
Time is set with ENTER!
3. Leap second mode:
 - 0 off
 - 1 Additional second will be inserted at entered time
Is set to 0=off after inserting the leap second.
 - 1 Second will be left out at entered time
Is set to 0=off after inserting the leap second.
 - 2 Recognize leap second automatically. Only possible with a source with leap second announcement!
4. Set UTC time of leap second in format: "hh:mm:ss DD.MM.YY"

For a description of the leap second, see chapter "8.8 Leap second"



Notice: Manual time set can be used for test purposes.
For normal operation a time source is highly recommended!
After manual time set, all other time sources are deactivated!
→ The device needs to be restarted, to change to any other time source.



Notice: After Manual time set the accuracy value for "**Free-run time deviation never synchronized**" has to be used, see appendix G Technical data.

6.5.12 Redundant operation settings

```
DTS 4160.grandmaster Moser-Baer AG
=====

REDUNDANT OPERATION
1 Alarm offset to master          1000ns
2 Set master manually

98 Return and save
99 Return and discard changes

Enter desired menu number>
```

Path: 2 Configuration → 2 Time handling → 4 Redundant operation

1. Max. offset to master for triggering the alarm “Too high offset to Master” (100-250’000’000ns)
2. Manual change from slave to master. The command is effected immediately. Saving with ‘98’ is not required when exiting the menu.

For a description of redundant operation, see chapter “8.15 Redundant operation of 2 DTS 4150 or 4160.grandmaster”

6.5.13 NTP server settings

DTS 4160:

```
DTS 4160.grandmaster Moser-Baer AG
=====

NTP SERVER CONFIGURATION GENERAL          PAGE 1/2

5 NTP Authentication
  NTP slave clock line (info only)

Press enter for next part, 99 to leave

Enter desired menu number>
```

Path: 2 Configuration → 2 Time handling → 5 NTP server settings

Page 1:

- 5 NTP Authentication: Changes to the menu “NTP AUTHENTICATION”
Information about a multicast – address, configured for NTP slave clocks.

Page 2:

Up to 4 multicast or broadcast addresses can be configured. Select to configure.



Notice: LAN ports share configured multi-/broadcast addresses regarding the following table:

LAN 1-4: Multi-/broadcast addresses 1-4

DTS 4150:

```
DTS 4150.grandmaster Moser-Baer AG
=====

NTP SERVER CONFIGURATION GENERAL          PAGE 1/2
1 Configuration timeserver address 1
2 Configuration timeserver address 2
3 Configuration timeserver address 3
4 Configuration timeserver address 4
5 NTP Authentication
  NTP slave clock line (info only)
7 NTP timesource settings

Press enter for next part, 99 to leave

Enter desired menu number>
```

Path: 2 Configuration → 2 Time handling → 5 NTP server settings

Page 1:

- 1 – 4 Configuration timeserver IP address x
Up to 4 external NTP servers can be defined as time source.
Select to configure and display changes to the menu "ENTRY TIMESOURCE"
- 5 NTP Authentication: Changes to the menu "NTP AUTHENTICATION"
Information about a multicast-address, configured for NTP slave clocks.
- 7 NTP timesource settings.
Select for "NTP TIMESOURCE SETTINGS" menu

Page 2:

Up to 4 multicast or broadcast addresses can be configured.
Select to configure.

DTS 4150:

Configuration of the individual server/peer address:

```
DTS 4150.grandmaster Moser-Baer AG
=====

ENTRY TIMESOURCE          1
1 Source                  ntp.test.org
2 Minpoll                 1
3 Maxpoll                 1
4 Server/Peer             server
5 Prefer                  off
6 Authentication key      off

98 Return and save
99 Return and discard changes

Enter desired menu number>
```

Path: 2 Configuration → 2 Time handling → 5 NTP server settings → 1..4 Configuration timeserver address x

1. Insert time sources (IP-address or Name e.g. "ntp.metas.ch")
ENTER without entry of an address will delete value.

- 2.-3. Configurations of **Minpoll** and **Maxpoll**: Inquiry interval $2^{\text{poll value}}$ in seconds.
 0 = automatically
 e.g. poll value=2 → interval 2: $2^2 = 4\text{sec.}$, poll value=5 → interval 5: $2^5 = 32\text{sec.}$
 Range of poll values (exponent): 1 – 16
4. Set type of inquiry: server or peer (default: server)
5. Preferred source: on or off
 If possible, one source should always be preferred (even if only one source is defined).
6. Authentication key: off, key number, autokey



Important: It is strongly recommended to set minpoll and maxpoll both to 1 in order to ensure accurate synchronization.
 For values other than 1 correct function of NTP as timesource cannot be ensured.



Notice: If a key number is entered, the entered key must also be added to the trusted keys.



Important: All changes lead to a **restart** of the NTP server!

MOBA-NMS: NTP Time server configuration

DTS 4150:

NTP Timesource settings:

```

DTS 4150.grandmaster Moser-Baer AG
=====

NTP TIMESOURCE SETTINGS
1 Alarm offset to NTP Server (ns)          1000000ns

98 Return and save
99 Return and discard changes

Enter desired menu number>
  
```

Path: 2 Configuration → 2 Time handling → 5 NTP server settings → 7 NTP Timesource settings

- Alarm "offset to NTP Server"
 0=off -> No Alarm released
 100 – 250'000'000-> offset to NTP server in ns
 The alarm message "Too high offset to NTP " occurs, when the offset of the internal time to the NTP server is larger than the defined value.
 => A value greater or equal to 100'000'000ns is recommended.

MOBA-NMS: NTP Timesource settings

The screenshot shows a web-based configuration interface for MOBA-NMS. At the top, there are several tabs: 'GNSS settings', 'Red. link settings', 'PTP settings', 'DCF settings', and 'NTP settings'. Under the 'NTP settings' tab, there are sub-tabs: 'NTP server', 'NTP LAN 1-4', 'Authentication', and 'NTP Source'. The 'NTP Source' sub-tab is active, showing a text input field for 'NTP Source max. Offset' with the value '100000000' entered. There are also small up and down arrow icons to the right of the input field.

Configuration of the NTP Authentication:

The NTP authentication is described in chapter "8.9 NTP Authentication".

```

DTS 4160.grandmaster Moser-Baer AG
=====

NTP AUTHENTICATION
1 Import keys (from /ram)
2 Export keys (to /ram)
3 Trusted (active) keys
4 Request keys (ntpq) off
5 Control keys (ntpd) off
6 Autokey password
7 Autokey command
8 Access control for query

98 Return and save
99 Return and discard changes

Enter desired menu number>
  
```

Path: 2 Configuration → 2 Time handling → 5 NTP server settings → 5 NTP Authentication

- Import keys (from /ram directory)
 The file *ntp.keys* must first be copied into the directory /ram.

Notice: The file must be named exactly in this way and written in small letters.
 The configured keys will be compared with the keys in the file. Is a key configured on the device and it is not in the key file, an alarm will appear (NTP authentication error).

- Export keys (to /ram directory)
 The current *ntp.keys* file is written in the directory /ram.
- Select the trusted keys separated by space
- Select the request key
- Select the control key
- Set the auto key password



7. Execute for auto key commands:
- | | |
|---------------|---|
| gen_iff | generate the IFF certificate |
| gen_gq | generate the GQ certificate |
| gen_mv* | generate the MV certificate |
| gen_all* | generate all (IFF,GQ,MV) certificates |
| gen_client | generate the client certificate |
| update_server | update the server certificate |
| update_client | update the client certificate |
| export_iff | export the IFF server certificate to /ram. Parameter password of the client |
| export_gq | export the GQ server certificate to /ram. |
| export_mv* | export the MV server certificate to /ram. |
| import_iff | import the IFF server certificate from /ram. |
| import_gq | import the GQ server certificate from /ram. |
| import_mv* | import the MV server certificate from /ram. |
| clear_ram | delete the certificates in /ram |
| clear_keys | delete the certificates in the NTP key directory |

Example: *export_iff myPassword* exports the IFF client certificate to /ram.

8. Access control for query: 0 = full access
 1 = local
 2 = no access (ntpq queries switched off)

*MV schema is currently not available

MOBA-NMS: NTP Authentication settings – Access control for ntp queries

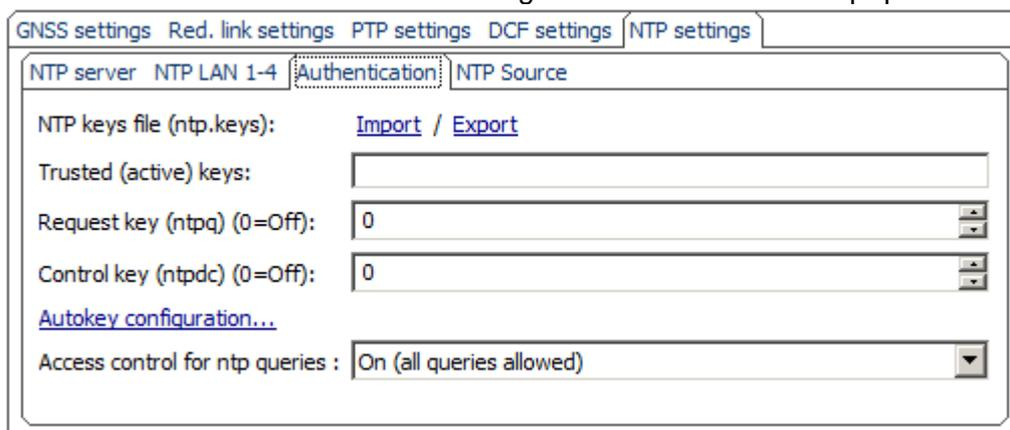

GNSS settings Red. link settings PTP settings DCF settings **NTP settings**

NTP server NTP LAN 1-4 **Authentication** NTP Source

NTP keys file (ntp.keys): [Import](#) / [Export](#)

Trusted (active) keys:

Request key (ntpq) (0=Off):

Control key (ntpd) (0=Off):

[Autokey configuration...](#)

Access control for ntp queries :

NTP Multicast / Broadcast Configuration

Configuration of the Multi- / Broadcast address is as follows:

```
DTS 4160.grandmaster Moser-Baer AG
=====

NTP MULTI- / BROADCAST-ENTRY
1 Multi- or broadcast IP address      254.192.1.1
2 Interval                            4sec
3 TTL (only for multicast)           1hops
4 Authentication key                  off

98 Return and save
99 Return and discard changes

Enter desired menu number>
```

Path: 2 Configuration → 2 Time handling → 5 NTP server settings → Page 2

1. IP address of the destination network (multicast or broadcast).
ENTER without entering an address will delete the entry.
2. Interval for sending out the NTP information in seconds.
The interval is rounded after the entry to NTP standard, which only permits values of format 2^x: 1,2,4,8,16,32,64... Maximum 65536 seconds.
3. TTL (time to live) in hops. Only required for multicast.
Number of routers over which the multicast packet should be transmitted: for simple networks without a router - enter 1, for 1 router - enter value 2.
4. Authentication key: off, key number, autokey



Notice: All changes lead to a restart of the NTP server.



Important: If an authentication key number is defined (see no 4.), the same key number must be also added to the trusted keys.

MOBA-NMS: NTP Multicast / Broadcast server configuration

NMS: Multicast / Broadcast server configuration

Multicast / Broadcast server configuration

Multi- or broadcast IP address: 239.192.1.1

Interval: 2

TTL (only for multicast): 1

Auth. key (0=Off): 0 Autokey

OK Cancel

6.5.14 PTP Configurations

```
DTS 4160.grandmaster Moser-Baer AG
=====

PTP CONFIGURATIONS
1 PTP config 1
2 PTP config 2
3 PTP config 3
4 GENRAL PTP configuration
5 PTP slave settings

99 Return

Enter desired menu number>
```

Path: 2 Configuration → 2 Time handling → 6 PTP settings

PTP config x - page 1:

```
DTS 4160.grandmaster Moser-Baer AG
=====

PTP CONFIGURATION                                config 1  PAGE 1/3
1 Profile                                       None
2 Mode                                         0
3 Delay mechanism                             E2E
4 Transport protocol                          IPv4
5 IPv6 scope                                  0xE
6 Priority 1                                   128
7 Priority 2                                   128

98 Return and save
99 Return and discard changes

Enter desired menu number>
```

Path: 2 Configuration → 2 Time handling → 6 PTP settings → 1 PTP config 1

1. Profile 0 = none, 1 = default, E2E, 2 = default P2P,
 3 = utility(IEC 61850-9-3), 4 = ITU-T G.8265.1,
 5 = ITU-T G.8275.1, 6 = ITU-T G.8275.2, 7 = IEEE
 802.1AS (gPTP)
2. Mode 0 = off, 1 = Multicast 1- Step, 2 = Multicast 2 - Step,
 3 = Unicast 1-Step, 4 = Unicast 2-Step
3. Delay mechanism 0 = E2E, 1 = P2P, default E2E
4. Transport protocol 0 = IPv4, 1 = IPv6, 2 = layer 2, default IPv4
5. IPv6 scope 1..15, default 15 (0xE)
6. Priority 1 0-255, default 128
7. Priority 2 0-255, default 128

Press ENTER to change to page 2.

PTP config x - page 2:

```
DTS 4160.grandmaster Moser-Baer AG
=====

PTP CONFIGURATION                                config 1  PAGE 2/3
8  Domain                                        0
9  LOG Announce interval                        1 (2 second)
10 LOG Sync interval                            0 (1 second)
11 LOG Delay Request interval                  0 (1 second)
12 Announce TO                                  3s
13 Sync TO                                      3s
14 UDP TTL                                      1

98 Return and save
99 Return and discard changes

Enter desired menu number>
```

Path: 2 Configuration → 2 Time handling → 6 PTP settings → 1 PTP config 1 [Enter]

- 8. Domain 0-255, default 0
 - 9. LOG Announce interval -7..7, default 1, values in format 2x sec (every 2 sec)
 - 10. LOG Sync interval -7..7, default 0, values in format 2x sec (every sec)
 - 11. LOG Delay Request Interval -7..7, default 0, values in format 2x sec (every sec)
 - 12. Announce TO 2..10, default 3s
 - 13. Sync TO 2..10, default 3s
 - 14. UDP TTL 1-255, default 1
- Press ENTER to change to page 3.

PTP config x - page 3:

```
DTS 4160.grandmaster Moser-Baer AG
=====

PTP CONFIGURATION                                config 1  PAGE 3/3
15 Master Only                                  False
16 Request duration                             3600
17 Port Local Priority                           128
18 LOG Query interval                            1
19 C37.238 Grandmaster ID                       0

98 Return and save
99 Return and discard changes

Enter desired menu number>
```

Path: 2 Configuration → 2 Time handling → 6 PTP settings → 1 PTP config 1 [Enter] [Enter]

- 15. Master Only 0 = False 1 = True, default 0
 - 16. Request duration 0 – 86400s, default 3600s
 - 17. Port Local Priority 0 – 255, default 128
 - 18. LOG Query interval 2
 - 19. C37.238 Grandmaster ID 0
- Press ENTER to change to page 1.

MOBA-NMS: Tab: PTP configuration, up to 3 configurations can be defined

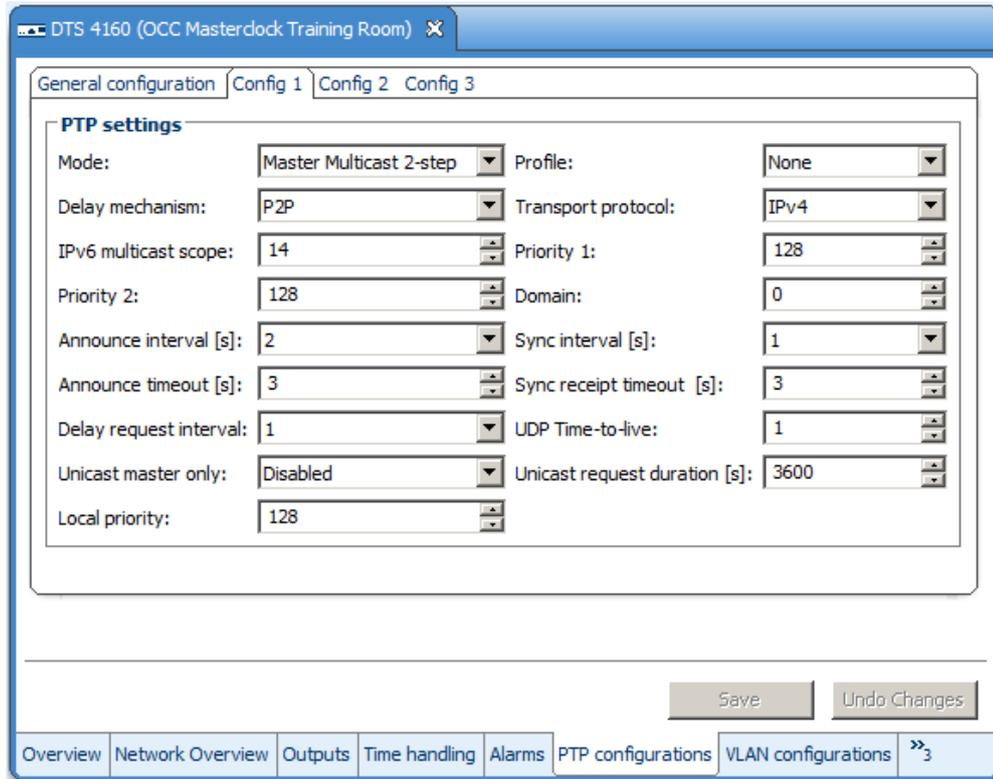

General PTP configuration:

```
DTS 4160.grandmaster Moser-Baer AG
=====

PTP GENERAL CONFIGURATION
1 UTC leap offset (TAI-UTC)          37

98 Return and save
99 Return and discard changes

Enter desired menu number>
```

Path: 2 Configuration → 2 Time handling → 6 PTP settings → 4 General PTP configuration

1. UTC leap second offset (TAI-UTC)

PTP slave settings:

```
DTS 4160.grandmaster   Moser-Baer AG
=====

PTP SLAVE SETTINGS
1 LAN interface                LAN2
2 Alarm offset to PTP Master   200ns
3 PTP Unicast Master Table

98 Return and save
99 Return and discard changes

Enter desired menu number>
```

Path: 2 Configuration → 2 Time handling → 6 PTP settings → 5 PTP slave settings

1. LAN interface for the PTP time source, PTP slave (LAN2 – LAN4)
2. Max. offset to PTP Master to trigger the alarm “Time source big offset“ (100ns – 5’000’000ns)
3. PTP Unicast Master Table. Up to 8 master addresses can be configured

MOBA-NMS: Tab: PTP configuration

General configuration | Config 1 | Config 2 | Config 3

PTP master

IP address 1:

IP address 2:

IP address 3:

IP address 4:

IP address 5:

IP address 6:

IP address 7:

IP address 8:

General configuration

UTC leap offset (TAI-UTC) [s]:

6.5.15 GNSS settings

GNSS settings – Page 1

```
DTS 4160.grandmaster Moser-Baer AG
=====

GNSS SETTINGS                                     PAGE 1/2
1 GNSS Constellation                             GPS & GLONASS
2 Alarm Source Offset                             200
3 Min. number of satellites                       5
4 Min. signal level of satellites (dbHz)         20dbHz
5 Antenna power supply voltage (V)              5V
6 Total Antenna delay (ns)                       0ns

98 Return and save
99 Return and discard changes

Enter desired menu number>
```

Path: 2 Configuration → 2 Time handling → 7 GNSS settings

- | | |
|---|----------------------------------|
| 2. GNSS Constellation | Supported Satellite Systems are: |
| DTS 4150: | GPS, GLONASS, Galileo, BeiDou |
| DTS 4160: | GPS, GLONASS, BeiDou |
| 3. Alarm Source Offset | 100 - 250000000ns, 0=off |
| 4. Min. number of satellites | 5 |
| 5. Min. signal level of satellites (dbHz) | 20dbHz |
| 6. Antenna power supply voltage (V) | 0=5V, 1 = 3.3V |
| 7. Total Antenna delay (ns) | 0 – 1000ns |

GNSS settings – Page 2

```
DTS 4160.grandmaster Moser-Baer AG
=====

GNSS SETTINGS                                     PAGE 2/2
9 Fixed Position Mode (FPM) (0=off, 1=on)      0
10 FPM minimum observation time (sec)           86400sec
11 FPM minimum position accuracy (mm)          1000mm

98 Return and save
99 Return and discard changes

Enter desired menu number>
```

Path: 2 Configuration → 2 Time handling → 7 GNSS settings

- | | |
|--|----------------------------------|
| 9. Fixed Position Mode (FPM) (0=off, 1=on) | 0 |
| 10. FPM minimum observation time (sec) | 86400sec (0s – 604800s) (1 week) |
| 11. FPM minimum position accuracy (mm) | 1000mm |



Notice: All changes lead to a restart of the internal GNSS Module.
 During the reconfiguration procedure the following alarms can occur:

- “Time Source- Big offset”
- “Time source fail TO”
- “Lost GNSS time source”



Notice: The resynchronization to the new settings takes up to 10 minutes typically

MOBA-NMS: Tab: Time handling – Tab: GNSS settings

GNSS settings	Red. link settings	PTP settings	GNSS-DCF settings	E1 settings	NTP settings
Fixed Position Mode (0=off, 1=on)	Off				
FPM minimum observation time (sec)	86400				
FPM minimum position accuracy (mm)	1000				
Min. required satellites	5				
Min. required signal level (dBHz)	20				

6.5.16 GNSS-DCF settings (GNSS-DCF Input)

```

DTS 4160.grandmaster Moser-Baer AG
=====

DCF SETTINGS
1 Offset correction value          500
2 Max offset to source            500

98 Return and save
99 Return and discard changes

Enter desired menu number>
  
```

Path: 2 Configuration → 2 Time handling → 8 GNSS-DCF settings

1. Offset correction value: With the offset correction value the cable delay can be compensated (0ns–10000ns)
2. Alarm Source Offset 100 - 250000000ns, 0=off



Notice: We recommend that the offset correction value is at least 500ns because of the hardware delay.
 We recommend that a second source is used to calibrate the GNSS-DCF.
 Only a **high precision DCF signal**, e.g. from another DTS 4160/4210 or from GPS/GNSS 4500 or GNSS 3000 is supported.
 The received DCF signal must contain UTC timezone.
 The DCF input only works with DTS device (HW) revision 03 or higher!

6.5.17 E1 settings (E1 Input)

Only applicable for DTS 4160 !

```
DTS 4160.grandmaster Moser-Baer AG
=====

E1 SETTINGS
1 Alarm offset to source          500
2 QL option (only option I supp)  1

98 Return and save
99 Return and discard changes

Enter desired menu number>
```

Path: 2 Configuration → 2 Time handling → Enter → 9 E1 settings

1. Alarm offset to source: 100 - 250000000ns, 0=off
2. QL option: This setting is not configurable, because at the moment only option I of the quality level is supported.

6.5.18 F-IN settings (Frequency Input)

Only applicable for DTS 4160 !

```
DTS 4160.grandmaster Moser-Baer AG
=====

F-IN SETTINGS
1 Alarm offset to source          500
2 Mode                            1

98 Return and save
99 Return and discard changes

Enter desired menu number>
```

Path: 2 Configuration → 2 Time handling → Enter → 10 F-IN settings

1. Alarm offset to source: 100 - 250000000ns, 0=off
2. Mode: F-IN Mode 1=10MHz, 2=2.048MHz, 3=PPS

Alarm Source offset makes only sense in the Mode 3 = PPS, in every other mode only the frequency is stabilized and not the offset.

Notice: Option 3, PPS, is available from hardware revision 04.
Prior hardware revisions supports 10MHz only



6.5.19 Alarms

Under alarms, settings can be done for the following functions:

- Alarm relay → see chapter 6.5.20
- E-mail → see chapter 6.5.22
- SNMP traps → see chapter 6.5.23

6.5.20 Alarm relay

```
DTS 4160.grandmaster Moser-Baer AG
=====

ALARM CONFIGURATION 2
1 Alarmmask for relay

98 Return and save
99 Return and discard changes

Enter desired menu number>
```

Path: 2 Configuration → 3 Alarms → 1 Alarm relay

1. Alarm mask for relay (see chapter "6.5.21 Alarm mask")

MOBA-NMS: Tab: Alarms

E-Mail

Send alarm e-mails

Alarmmask: [Change...](#)

Mailserver address:

Port (default 25):

Authentication mode:

Username:

Password:

Destination mail address 1:

Destination mail address 2:

Reply mail address:

From mail address:

Traps

Send SNMP traps

Alarmmask: [Change...](#)

Trap community string:

Alive messages interval (0=off) [s]:

Traps destination 1

Destination address:

Destination port (default 162):

SNMP version:

Traps destination 2

Destination address:

Destination port (default 162):

SNMP version:

Alarm relay

Alarmmask: [Change...](#)

Overview | Network Overview | Outputs | Time handling | **Alarms** | PTP configurations | VLAN configurations | Network | SNMP | General, Services

Click on "Change..." to open the alarm mask (see chapter "6.5.21 Alarm mask").

6.5.21 Alarm mask

```

DTS 4160.grandmaster Moser-Baer AG
=====

ALARMMASK                                     Page 1
[ ]=error disabled, [*]=error enabled
[*] Bit00: DTS restart                        [*] Bit01: System warning
[*] Bit02: Supply voltage too low           [*] Bit03: Failure supply 1
[*] Bit04: Internal voltage to low          [*] Bit05: Error bit5
[*] Bit06: Error bit6                        [*] Bit07: Error bit7
[*] Bit08: Wrong time zone DCF              [*] Bit09: Error Time Zone TC
[*] Bit10: Error bit10                      [*] Bit11: Error bit11
[*] Bit12: Error bit12                      [*] Bit13: Oscillator not locked
[*] Bit14: GNSS synch lost                  [*] Bit15: Time source big offset

Enter alarm number to alter mask

Press ENTER for next part, 99 to leave>

```

Path: 2 Configuration → 3 Alarms → 1 Alarm relay → 1 Alarm mask for relay

Display of all the DTS 4160 alarms (64) on 4 pages. Pages can be scrolled through with ENTER.

An alarm on the current page can be switched on or off by entering an error number. The page can be exited with 99. The modifications will be saved or restored one menu level higher in "ALARM CONFIGURATION". All Alarms with "error bitxx" are not yet used.

A description of individual errors can be found in appendix "B Time zone table"

MOBA-NMS: Tab: Alarms → Alarm mask

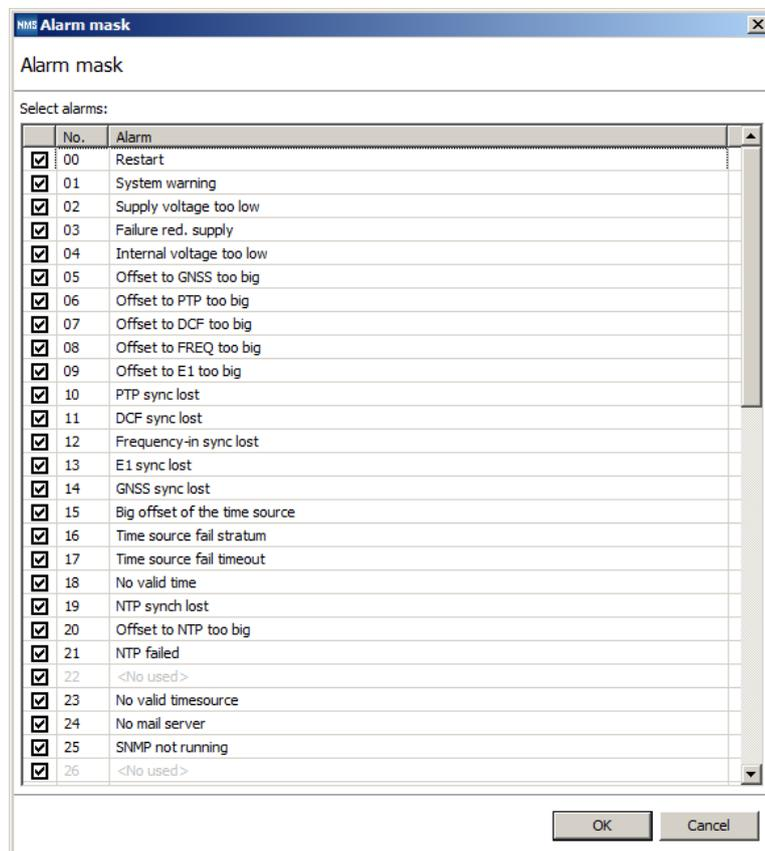

6.5.22 E-mail

```
DTS 4160.grandmaster Moser-Baer AG
=====

MAIL CONFIGURATION                               Page 1
1 Mailmode                                       off
2 Alarmmask for mail                             ff ff ff ff ff ff ff ff
3 Mailserver
4 Mailport (default 25)                          25
5 Destination mail address1
6 Destination mail address2
7 Reply mail address
8 From mail address

98 Return and save
99 Return and discard changes

Enter desired menu number>
```

Path: 2 Configuration → 3 Alarms → 2 E-Mail

1. E-mail function on or off.
2. Alarm mask for e-mail notifications (see chapter "6.5.21 Alarm mask")
Changes are stored or reset on the overlying menu page "MAIL CONFIGURATION".
3. IP address of the mail server e.g. 10.249.34.5
ENTER without entering an address will delete the entry.
4. Mail server port (often 25)
- 5.-6. Destination e-mail address.
ENTER without entering an address will delete the entry.
7. Reply address (e.g. support, administrator...)
ENTER without entering an address will delete the entry.
8. Sender address (important for authentication through the mail server)
ENTER without entering an address will delete the entry.

Press ENTER to change to page 2.



Notice: Configuration of a gateway is required for sending e-mails (see chapter "6.5.25 Network"). This can be set via DHCP or manually.

E-mail configuration page 2:

```
DTS 4160.grandmaster Moser-Baer AG
=====

MAIL CONFIGURATION                               Page 2
11 Authentication mode                            0
12 User name
13 Password

98 Return and save
99 Return and discard changes

Enter desired menu number>
```

Path: 2 Configuration → 3 Alarms → 2 E-Mail [Enter]

11. Authentication mode:

- 0 = off (sender e-mail address used for authentication)
- 1 = auto (tries CRAM-MD5, LOGIN- PLAIN in this sequence)
- 2 = PLAIN
- 3 = LOGIN
- 4 = CRAM-MD5

12. User name (only for authentication mode 1-4)

13. Password (only for authentication mode 1-4)

Press ENTER to change to page 1.

Format of an error message via E-mail:

```
Event <Alarm 03 set: Power failure 1>
Time <11:26:45 10.01.07>
Hostname <DTS4160 (10.241.0.30)>
```

MOBA-NMS: Tab: Alarm, Frame: E-Mail

The screenshot shows the configuration interface for E-Mail and Traps in the MOBA-NMS system. The interface is divided into two main sections: E-Mail and Traps.

E-Mail Configuration:

- Send alarm e-mails
- Alarmlist: [ff ff ff ff ff ff ff ff] [Change...](#)
- Mailserv address: [10.240.0.140]
- Port (default 25): [25]
- Authentication mode: [Off (Use sender mail address)]
- Username: []
- Password: []
- Destination mail address 1: [support@mobatime.com]
- Destination mail address 2: []
- Reply mail address: []
- From mail address: []

Traps Configuration:

- Send SNMP traps
- Alarmlist: [ff ff ff ff ff ff ff ff] [Change...](#)
- Trap community string: [trapmobatime]
- Alive messages interval (0=off) [s]: [30]

Traps destination 1:

- Destination address: [10.240.10.141]
- Destination port (default 162): [162]
- SNMP version: [2c]

Traps destination 2:

- Destination address: []
- Destination port (default 162): [162]
- SNMP version: [2c]

Alarm relay:

- Alarmlist: [ff ff ff ff ff ff ff ff] [Change...](#)

Buttons: Save, Undo Changes

Navigation tabs: Overview, Network Overview, Outputs, Time handling, Alarms, PTP configurations, VLAN configurations, Network, SNMP, General, Services

6.5.23 SNMP traps

For a description of SNMP functionality, see also chapter "9 SNMP". Traps are also designated as notifications (from SNMP V2)

```
DTS 4160.grandmaster Moser-Baer AG
=====

SNMP-TRAP CONFIGURATION
1 Trap mode off
2 Alarmmask for trap ff ff ff ff ff ff ff ff
3 Trap community string trapmobatime
4 Configuration of destination 1
5 Configuration of destination 2
6 Time periode for alive message 0

98 Return and save
99 Return and discard changes

Enter desired menu number>
```

Path: 2 Configuration → 3 Alarms → 3 Traps

1. Trap mode on or off (applies to alarm and alive traps)
2. Alarm mask for SNMP trap messages (see chapter "6.5.21 Alarm mask")
Changes are first stored or reset on the overlying menu page "SNMP TRAP CONFIGURATION".
3. Trap community string (group membership for traps).
Standard: *trapmobatime*.
4. Configuration of the receiving system (trap sink) 1
5. Configuration of the receiving system (trap sink) 2
6. Time period for alive messages in seconds. 0 = no alive traps are sent
Range: 1-7'200sec



Notice: General settings for SNMP can be found in menu '2. Configuration' → '7. SNMP'. See also chapter "6.5.30 SNMP").

Notice: Configuration of a gateway is required for sending SNMP traps (see chapter 6.5.25 Network). This can be set via DHCP or manually.

Notice: Each configuration change leads to a restart of the DTS SNMP Agent.

Configuration of the receiving systems

```
DTS 4160.grandmaster Moser-Baer AG
=====

SNMP-TRAP DESTINATION CONFIGURATION      1
1 Address trap destination
2 Port trap destination (default 162)    162
3 SNMP version                           2

98 Return and save
99 Return and discard changes

Enter desired menu number>
```

Path: 2 Configuration → 3 Alarms → 3 Traps → 4 Configuration of destination 1

1. Address of the evaluation system e.g. 10.240.0.9.
ENTER without entering an address will delete the entry.
2. Port of the evaluation system (usually 162).
3. SNMP Version: 1=SNMP V1, 2=SNMP V2c



Notice: Each configuration change leads to a restart of the DTS SNMP Agent.

MOBA-NMS: Tab: Alarm, Frame: Traps

E-Mail

Send alarm e-mails

Alarmmask: [Change...](#)

Mailserver address:

Port (default 25):

Authentication mode:

Username:

Password:

Destination mail address 1:

Destination mail address 2:

Reply mail address:

From mail address:

Alarm relay

Alarmmask: [Change...](#)

Traps

Send SNMP traps

Alarmmask: [Change...](#)

Trap community string:

Alive messages interval (0=off) [s]:

Traps destination 1

Destination address:

Destination port (default 162):

SNMP version:

Traps destination 2

Destination address:

Destination port (default 162):

SNMP version:

Overview | Network Overview | Outputs | Time handling | **Alarms** | PTP configurations | VLAN configurations | Network | SNMP | General, Services

6.5.24 General settings

```
DTS 4160.grandmaster Moser-Baer AG
=====

GENERAL SETTINGS
  Language (info only)           English
  2 Timezone displayed times     [+1] Brussel
  3 Power (0=single, 1=red.)     0
  4 Password (menu)              dts
  5 USB port                      on

98 Return and save
99 Return and discard changes

Enter desired menu number>
```

Path: 2 Configuration → 4 General

Device/Display Language

2. Setting the time zone for the display, and also all alarm logs, e-mail and SNMP. (See chapter 6.5.33 Time zone selection).
3. Power: 0=single power, 1=redundant power (2 power supplies) (See chapter “10 Redundant Power supply “)
4. Enter password for the menu (user **dts**) (max. 15 characters). A password must be configured.
5. USB port: 0=off, 1=on

MOBA-NMS: Tab: General, Services

The screenshot shows the MOBA-NMS configuration interface for the General, Services tab. The interface is divided into several sections:

- Menu / Display:** Time zone is set to 2: [+1] Brussel. A [Change...](#) link is available.
- Password for telnet, SSH and FTP:** Password "dts" user is masked with three dots.
- Services:** Telnet, FTP, and SSH, SCP, SFTP are all set to Enabled.
- Power:** Power supply is set to Single (radio button selected).

At the bottom right, there are [Save](#) and [Undo Changes](#) buttons. At the bottom, a navigation bar includes: Overview, Network Overview, Outputs, Time handling, Alarms, PTP configurations, VLAN configurations, Network, SNMP, and General, Services (selected).

6.5.25 Network

```

DTS 4160.grandmaster Moser-Baer AG
=====

NETWORK INTERFACES
1 LAN 1
2 LAN 2
3 LAN 3
4 LAN 4

99 Return

Enter desired menu number>

```

Path: 2 Configuration → 5 Network

MOBA-NMS: Tab: Network – LAN x

The screenshot shows the configuration page for LAN 1 in the MOBA-NMS interface. The page is titled "DTS 4160 (E2)" and has tabs for LAN 1, LAN 2, LAN 3, and LAN 4. The "LAN 1" tab is active.

General network settings: Host name: dts4160, Domain name: (empty).

IPv4 configuration: DHCP: Enabled, DNS server: 0.0.0.0. Two IP address sections are shown, both with IP address, Subnet mask, and Gateway set to 0.0.0.0, and two static routes with IP address/Prefix set to 0.0.0.0 / 24.

IPv6 configuration: Auto conf: Disabled, DHCP V6: Disabled, IP address / Prefix: 0::0 / 64, Gateway: 0::0, IP address 2 / Prefix 2: 0::0 / 64, Gateway 2: 0::0, DNS server: 0::0.

Port configuration: Mode: Auto negotiation, PTP Support: Yes, PTP configuration: Disabled, LAG Support: Yes, LAG: Disabled, SyncE Support: Yes, SyncE configuration: Disabled.

VLAN configuration: VLAN configuration for IP 1: Disabled, VLAN configuration for IP 2: Disabled.

LAG configuration for LAN 2+3: Mode: 802.3ad, LACP Rate: Fast, MII mon. freq. [ms]: 100.

Buttons for "Save" and "Undo Changes" are located at the bottom right. A navigation bar at the bottom includes: Overview, Network Overview, Outputs, Time handling, Alarms, PTP configurations, VLAN configurations, Network, SNMP, General, Services.

Network Interface 1 – Page 1

```
DTS 4160.grandmaster Moser-Baer AG
=====

NETWORK GENERAL                                LAN 1  PAGE 1/2
1  IPV4 configuration
2  IPV6 configuration
3  Network interface config                    auto
4  Host name (Device name)                   dts4160
5  Domain name
6  IPV4 static routing

98 Return and save, ENTER for next part
99 Return and discard changes

Enter desired menu number>
```

Path: 2 Configuration → 5 Network → 1 LAN 1

1. Configuration of IPv4 parameters
2. Configuration of IPv6 parameters
3. Set network interface: Auto, 1000/100Mbit, half, full duplex.
4. Set host name.



Notice: A host name must always be configured.

Host names and their format are described in the Internet standards RFC 952 and RFC 1123:

Domains and host names may only contain letters (capitals or small letters) and numerals ("0-9"). In addition, the minus sign ("-") may also be used, as long as it is not at the end. **Everything else is not permitted!**

5. Set domain e.g. test.org
6. Define up to 2 static routing destinations for IP1 and IP2

View of the current network state in Menu: '1 Status' → '6 Info network config.'



Notice: After modifying the IP or the DHCP mode the menu is always closed.



Notice: DHCP on/off, each change of this setting will result in a **restart** of the NTP server!



Notice: For the operation of a **Multicast** communication (NTP and Time Zone Server) **the configuration of a gateway is mandatory**. The gateway can be set manually or by using DHCP. If no gateway is available, the own IP address can be used.



Notice: Only one DNS server should be configured (IPv4 or IPv6).



Notice: Modifications to the network must be coordinated with the network administrator!

Network Interface 1 – Page 2

```
DTS 4160.grandmaster Moser-Baer AG
=====

NETWORK GENERAL                                LAN 1  PAGE 2/2
11 Link aggregation                             1
12 VLAN config for IP1                         0
13 VLAN config for IP2                         0
14 PTP config                                  0
15 SyncE ESMC config                           0

98 Return and save, ENTER for next part
99 Return and discard changes

Enter desired menu number>
```

Path: 2 Configuration → 5 Network → 1 LAN 1 [Enter]

11. Configuration of link aggregation (only for LAN 2)
12. VLAN configuration for IP1: select predefined VLAN config 1 .. 16, 0=off
See chapter “6.5.28 VLAN configuration”
13. VLAN configuration for IP2: select predefined VLAN config 1 .. 16, 0=off

Notice: **VLAN configuration IP1 & IP2**

Mixed IP configuration, by means one IP with VLAN and the other IP without VLAN, are not supported by the device.

- Notice:** It is not supported to assign the same VLAN configuration to IP 1 and IP 2 of the same LAN port.

14. PTP configuration (only LAN 2, 3 and 4)
15. SyncE ESMC config

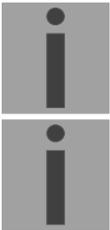

Network configuration IPv4:

```
DTS 4160.grandmaster Moser-Baer AG
=====

NETWORK IPV4                                LAN 1
1 DHCP                                       off
2 IP address 1                              192.168.0.10
3 Subnet mask 1                             255.255.255.0
4 Gateway 1                                 192.168.0.1
5 IP address 2                              192.168.1.10
6 Subnet mask 2                             255.255.255.0
7 Gateway 2                                 192.168.1.1
8 DNS server                                192.168.0.7

98 Return and save
99 Return and discard changes

Enter desired menu number>
```

Path: 2 Configuration → 5 Network → 1 Network IF 1 → 1 IPv4 configuration

1. DHCP on or off, the following fields are not available in case of DHCP = on. A DHCP **renew** can also be triggered via this point.

Notice: DHCP on, if no DHCP server is available, leads to longer start-up time (approx. + 60 sec.) of the DTS.

- 2.-8. Set IP address, subnet mask, gateway and DNS server. Format = 10.240.98.7

Network configuration IPv6:

```
DTS 4160.grandmaster Moser-Baer AG
=====

NETWORK IPV6                                LAN 1
1 Mode / Autoconf                           off
2 DHCPv6                                     off
3 IP address 1 / Prefix                      0::0/64
4 Gateway 1                                 0::0
5 IP address 2 / Prefix                      0::0/64
6 Gateway 2                                 0::0
7 DNS server                                0::0

98 Return and save
99 Return and discard changes

Enter desired menu number>
```

Path: 2 Configuration → 5 Network → 1 Network IF 1 → 2 IPv6 configuration

1. Autoconf on or off
2. DHCPv6 on or off
3. IP address with prefix in IPv6 format
e.g. 2001:2345:6789::12:1:34/64
4. Gateway in IPv6 format
5. IP address with prefix in IPv6 format
e.g. 2001:2345:6789::12:1:34/64



6. Gateway in IPv6 format
7. IPv6 DNS server

6.5.26 Link aggregation LAG

This device supports aggregation of two physical Ethernet ports to one logical high-bandwidth data path (LAG) compatible to IEEE 802.3ad. LAG can be used for fault tolerance (redundancy) and/or load balancing.

```

DTS 4160.grandmaster Moser-Baer AG
=====

NETWORK LINK AGGREGATION                LAN 2
1 Mode (0=off, 1=on)                      0
2 LAG Mode                                4
3 Rate (0=slow, 1=fast)                   1
4 MII monitor                             100ms

98 Return and save
99 Return and discard changes

Enter desired menu number>

```

Path: 2 Configuration → 5 Network → 2 LAN 2 → 11 Link aggregation

Notice: LAG is only possible for LAN 2+3.

The network configuration has to be done on the first interface LAN2.

1. Link aggregation on or off
2. LAG Mode
 - 0 = Round-robin
 - fault tolerance and load balancing
 - 1 = Active-backup, only one slave in the bond is active
 - fault tolerance
 - 2 = Balance-XOR
 - fault tolerance and load balance
 - 3 = Broadcast, transmit everything on all slave interfaces
 - fault tolerance
 - 4 = 802.3ad Dynamic link aggregation
 - fault tolerance and load balance
 - requires switch that supports IEEE 802.3ad
 - 5 = Adaptive transmit load balancing
 - fault tolerance and load balance
 - requires no special switch support
 - 6 = Adaptive load balancing, includes Adaptive transmit load
 - fault tolerance and load balance
 - balancing plus receive load balancing, requires no special switch support
3. Rate
 - 0 = slow, Request link partner to transmit LACPDU every 30 seconds
 - 1 = fast, Request link partner to transmit LACPDU every 1 second
4. Setting the MII link monitoring frequency (how often the link state of each slave is inspected for link failure)
 - 0 = off, 1..255ms



MOBA-NMS: Tab: Network, Frame: LAG configuration for LAN 2+3

Notice: LAG is only possible for LAN 2+3. The network configuration has to be done on LAN2



6.5.27 IPv4 static routing

For each LAN port up to 2 static routing destinations for IP1 and IP2 can be defined:

```

DTS 4160.grandmaster  Moser-Baer AG
=====

NETWORK IPV4 STATIC ROUTING                                LAN 1
1 IP1 network destination 1 / Prefix                       0.0.0.0/24
2 IP1 network destination 2 / Prefix                       0.0.0.0/24
3 IP2 network destination 1 / Prefix                       0.0.0.0/24
4 IP2 network destination 2 / Prefix                       0.0.0.0/24

98 Return and save
99 Return and discard changes

Enter desired menu number>
    
```

Path: 2 Configuration → 5 Network → 1 LAN 1 → 6 IPV4 static routing

Example: Route all addresses of range 192.168.0-255.0-255 add network destination 192.168.0.0/16

6.5.28 VLAN configuration

This device supports tagged VLAN (virtual LANs) configuration options compatible to IEEE 802.1p/1q.

You can define up to 4 different VLAN configurations.

```
DTS 4160.grandmaster Moser-Baer AG
=====

VLAN CONFIGURATION                                VLAN 1
1 Name
2 ID                                               1
3 PCP                                             0

98 Return and save
99 Return and discard changes

Enter desired menu number>
```

Path: 2 Configuration → 6 VLAN configuration → 1 VLAN config 1

1. Name of the VLAN (Max. 64 characters)
2. Setting the VLAN ID (1 - 4094)
3. - Priority Code Point according to IEEE 802.1Q
Default: PCP: 0

MOBA-NMS: Tab: VLAN configuration, e.g. Config 4

Up to 8 VLAN configurations can be defined. They can be assigned to network ports in Tab: Network. See next page.

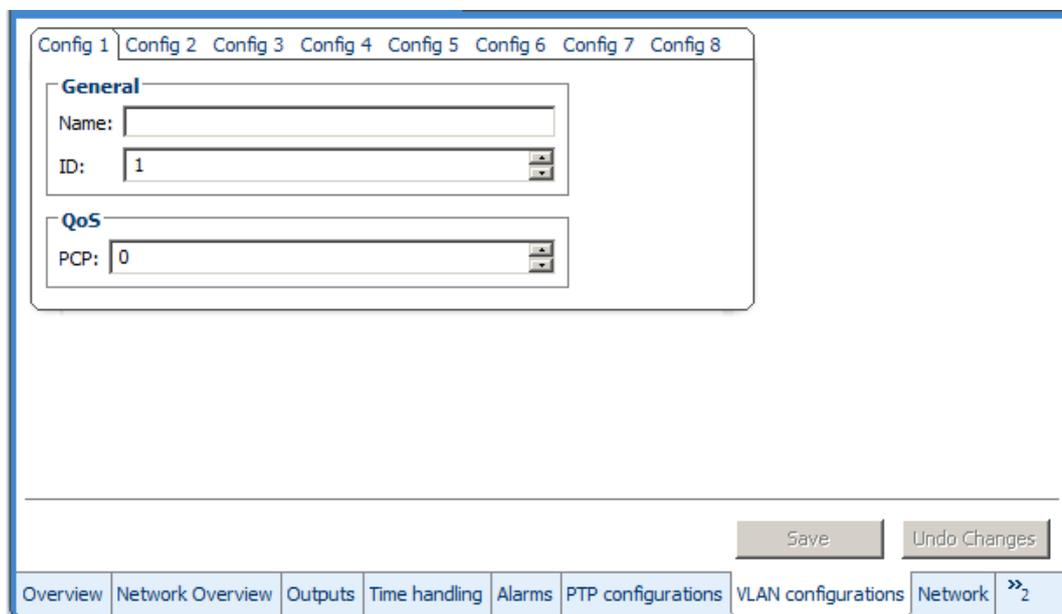

MOBA-NMS: Tab: Network, Frame: VLAN configuration

Assign the predefined VLAN config., e.g. Config 1 and Config 2 to IP 1 and IP 2.



6.5.29 Services (network services FTP, telnet, SSH...)

Network services configuration:

```
DTS 4160.grandmaster   Moser-Baer AG
=====

NETWORK SERVICES
1 telnet                on
2 ftp                   on
3 ssh, scp, sftp        on

98 Return and save
99 Return and discard changes

Enter desired menu number>
```

Path: 2 Configuration → 7 Services (FTP, telnet, SSH)

1.-3. Switch the individual services off or on.

MOBA-NMS: Tab: General, Services; Frame: Services

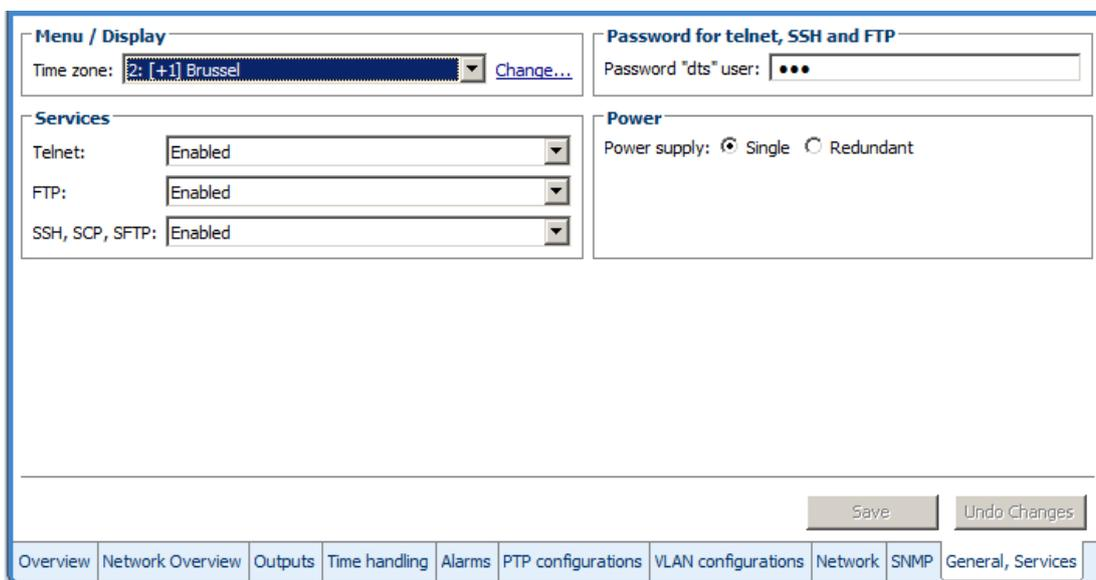

The image shows a web-based configuration interface for network services. At the top, there is a 'Menu / Display' section with a time zone dropdown set to '+1 Brussel' and a 'Change...' link. To the right is a 'Password for telnet, SSH and FTP' field with a masked password '***'. Below this is the 'Services' section, which includes three dropdown menus: 'Telnet: Enabled', 'FTP: Enabled', and 'SSH, SCP, SFTP: Enabled'. To the right of the services is a 'Power' section with a 'Power supply' option set to 'Single' (radio button selected) and 'Redundant' (radio button unselected). At the bottom right of the main content area are 'Save' and 'Undo Changes' buttons. A navigation bar at the very bottom contains several tabs: 'Overview', 'Network Overview', 'Outputs', 'Time handling', 'Alarms', 'PTP configurations', 'VLAN configurations', 'Network', 'SNMP', and 'General, Services' (which is the active tab).

6.5.30 SNMP

For a description of SNMP functionality, see also chapter “9 SNMP“.

```

DTS 4160.grandmaster Moser-Baer AG
=====

SNMP CONFIGURATION
1  SNMP mode                               2
2  Alarmmask for SNMP                      ff ff ff ff ff ff ff ff
3  DTS location
4  Contact information
5  SNMP V1/V2c security configuration
6  SNMP V3 security configuration

98 Return and save
99 Return and discard changes

Enter desired menu number>
    
```

Path: 2 Configuration → 8 SNMP

1. Mode. 0=off, 1=V1/V2c/V3, 2=V2c/V3, 3=V3.
SNMP information of MIB 2 is always available.

Notice: To send out MIB-2 traps, the trap community and the destination address must at least be configured in menu '2. Configuration' → '3. Alarms' → '3. Traps'. See also chapter “6.5.23 SNMP traps”.

2. Alarm mask for SNMP status (see chapter "6.5.21 Alarm mask"). The modifications will be saved or restored one menu level higher in “SNMP CONFIGURATION”.
3. DTS Location information, which is displayed in SNMP management tool.
4. Contact information, which is displayed in SNMP management tool.
5. Configuration of SNMP V1 / V2 c (specific settings). See chapter “6.5.31 SNMP V1 / V2c“
6. Configuration of SNMP V3 (specific settings). See chapter “6.5.32 SNMP V3“

Notice: Each configuration change leads to a restart of the DTS SNMP Agent.

MOBA-NMS: Tab: SNMP

6.5.31 SNMP V1 / V2c

```
DTS 4160.grandmaster Moser-Baer AG
=====

SNMP V1/V2c CONFIGURATION
1 Readonly community string          romobotime
2 Read/write community string        rwmobotime

98 Return and save
99 Return and discard changes

Enter desired menu number>
```

Path: 2 Configuration → 8 SNMP → 5 SNMP V1/V2c security configuration

1. Community string for **read only** (Group membership for GET).
Standard: *romobotime*.
2. Community string for **read/write** (Group membership for GET/PUT).
Standard: *rwmobotime*.



Notice: Each configuration change leads to a restart of the DTS SNMP Agent.

6.5.32 SNMP V3

```
DTS 4160.grandmaster Moser-Baer AG
=====

SNMP V3 CONFIGURATION
1 User 1 configuration (dtsUser1)
2 User 2 configuration (dtsUser2)
3 Access 1 configuration (viewDTS1)
4 Access 2 configuration (viewDTS2)

99 Return

Enter desired menu number>
```

Path: 2 Configuration → 7 SNMP → 6 SNMP V3 security configuration

1. – 2. Configuration of user-defined SNMP accounts *dtsUser1* and *dtsUser2*
3. – 4. Configuration of user-defined SNMP access rights *viewDTS1* and *viewDTS2*



Notice: Each configuration change leads to a restart of the DTS SNMP Agent.

User configuration SNMP V3:

```
DTS 4160.grandmaster Moser-Baer AG
=====

SNMP V3 USER CONFIGURATION                dtsUser1
1 Password for authent. and privacy        mobatime
2 Min security level                       auth
3 Read access (read view)                 _all_
4 Write access (write view)               viewDTS1

98 Return and save
99 Return and discard changes

Enter desired menu number>
```

Path: 2 Configuration → 8 SNMP → 6 SNMP V3 security configuration → 1 User 1 configuration (DTSUser1)

1. Password for authentication (MD5) and privacy (DES). 8 – 40 characters.
2. Minimal security level: 1=noauth (no authentication)
 2=auth (only authentication)
 3=priv (authentication and privacy)
3. SNMP read access: 0=none (no access)
 1=all (full access)
 2=DTS info (only DTS specific information)
 3=user defined 1 (viewDTS1)
 4=user defined 2 (viewDTS2)
4. SNMP write access 0=none (no access)
 1=all (full access)
 2=DTS info (only DTS specific information)
 3=user defined 1 (viewDTS1)
 4=user defined 2 (viewDTS2)



Notice: Each configuration change leads to a restart of the DTS SNMP Agent.

Access configuration SNMP V3:

```
DTS 4160.grandmaster Moser-Baer AG
=====

SNMP V3 ACCESS CONFIGURATION          viewDTS1
1 Include OID 1                       .1.3.6.1.4.1.8072
2 Include OID 2                       .1.3.6.1.4.1.2021
3 Include OID 3                       .1.3.6.1.4.1.13842.4
4 Exclude OID 1                       .2
5 Exclude OID 2                       .2
6 Exclude OID 3                       .2

98 Return and save
99 Return and discard changes

Enter desired menu number>
```

Path: 2 Configuration → 8 SNMP → 6 SNMP V3 security configuration → 3 Access 1 configuration (viewDTS1)

1. - 3. Include View path, form: `.1.3.6.1.4.1.13842.4` (e.g. DTS) or `.iso` (complete SNMP ISO path).
4. - 6. Exclude View path: analogue include.



Notice: Each configuration change leads to a restart of the DTS SNMP Agent.

6.5.33 Time zone selection

```
DTS 4160.grandmaster Moser-Baer AG
=====

SELECTION TIME ZONE                               Page 1
00: [0] UTC                                       01: [0] London
* 02: [+1] Brussel                               03: [+2] Athens
04: [+2] Bucharest                               05: [+2] Cairo
06: [+2] Amman                                   07: [0] UTC
08: [+3] Kuwait                                  09: [-1] Cape Verde
10: [0] UTC                                       11: [+4] Abu Dhabi
12: [+4.5] Kabul                                 13: [-8] Pitcairn Is.
14: [+5] Tashkent                               15: [+5.5] Mumbai
16: [+6] Astana                                  17: [+7] Bangkok
18: [+8] Singapore                              19: [+9] Tokyo

Enter requested time zone

Press enter for next part, ESC to leave>
```

Display of all the DTS 4160 time zones (100) over several pages. The pages can be scrolled through with ENTER.

A time zone can be selected on the current page by entering a time zone number.

Only one time zone can be selected.

A * indicates the selected time zone.

Press ESC to leave the page. The modifications will be saved or restored one menu level higher.

MOBA-NMS: For all outputs with time information like IRIG / AFNOR, DCF,... the time zone can be selected from predefined time zone table.

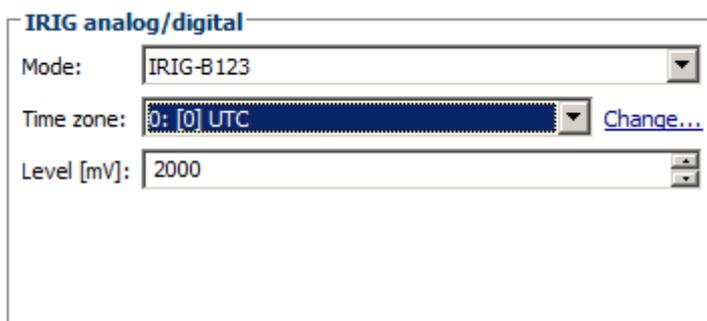

6.6 Maintenance menu

```
DTS 4160.grandmaster  Moser-Baer AG
=====

MAINTENANCE
1 Update software (FTP)
2 Update software (USB)
3 Backup configuration and log to USB
4 Backup configuration (local backup)
5 Restore configuration (local backup)
6 Restore configuration (default MOBA)
7 Restart device
8 Copy telegram files

99 Return

Enter desired menu number>
```

Path: 3 Maintenance

1. Initiating a software update (files must have been copied by FTP into the directory */ram* of the DTS 4160 before). → See chapter "7 Updates".
The command always leads to a restart of the DTS 4160 (even if no files were copied for update).

 **Notice:** Possibly save configuration first.

2. Initiate a software update (files must first be put onto a USB stick and this stick must be connected to the DTS 4160). → See chapter "7 Updates". The command always leads to a restart of the DTS 4160 (even if no files were copied for update)

 **Notice:** Possibly save configuration first.

3. Save the entire configuration (incl. telegram files) and the log files on a USB stick . Also generates a diagnosis file (*dts4160system_XXXXXXXXXX.log*) in the directory */ram* which is also copied on to the USB stick or which can be downloaded per FTP (only for support).
4. Backup the entire configuration locally (→ file *dts4160.conf.bkp* is created).
5. Restore the entire configuration from a backup stored locally.
6. Restore the entire configuration to factory settings.
7. Restart DTS 4160.
8. Copy telegram files onto the DTS 4160.
→ See chapter "7.10 Copying Telegram files to the DTS ".

See also chapter "7 Updates".

MOBA-NMS: Restart Device, Firmware Update, Time Zone Table Update

The above mentioned commands can be released by clicking with right mouse button to the device and selecting “Commands”.

The “Commands” menu can be also opened by clicking on “Command Icon”.

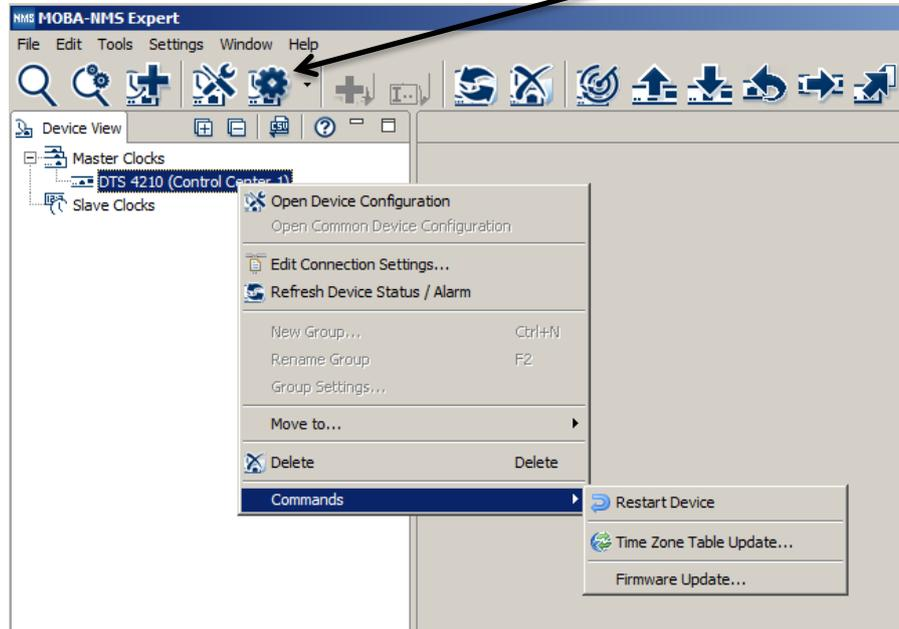

The following functions can be started via Menu “Edit”:

- Backup / Restore / Transfer configuration
- Reset to factory settings
- Export log files and configuration for support



7 Updates

7.1 Updating images with MOBA-NMS

Steps for updating images using MOBA-NMS:

1. Select DTS device(s) in the device view.
2. Menu 'Edit' → 'Commands' → Select 'Firmware Update...'
3. Enter the path to the file 'dtscheck.md5' or select it using the 'Browse...' button.
4. Enter further paths to images or select them using the 'Browse...' button.
5. Optionally: Check the box 'Backup device(s) configuration before update' and enter the destination directory for the backup file(s). If a destination folder is selected, the whole device configuration will be saved before the backup.
6. By clicking the 'OK' button, the update is initiated.



Important: The update procedure (item 6) can take some time (<5 min.) and may not be interrupted under any circumstances. In case of an interruption, the software on the DTS 4160 is destroyed and can only be repaired in the factory.

7.2 Updating images with FTP

Possible images are: dts4160_dts4210u-boot, dts4160_dts4210app.ubifs,
dts4160_dts4210rootfs.ubifs, dts4160_dts4210cfg.ubifs,
dts4160_dts4210ulmage, dts4160_dts4210devicetree.dtb.
Additionally the file **dts4160_dts4210check.md5** must exist.

→ all file names are case-sensitive.

Steps for updating images:

1. Connect a FTP client software to the DTS 4160 e.g. with Windows Explorer enter: **ftp://dts@[IP address]** (as user dts). See also chapter 7.6 FTP connection
2. Change to the directory */ram*.
3. Copy the image into the directory */ram*.
4. Close FTP connection.
5. The update procedure can be started on DTS 4160 by selecting the menu '3. Maintenance' → '1. Update software (FTP)' and press ENTER. The message "Update in progress" appears and at the same time, "Please wait!>" is shown in the command line. All images are copied. The DTS 4160 is automatically restarted on completion of the update.
The Telnet or SSH session has to be restarted.



Notice: The update procedure (point 5) may take some time depending on the type and number of images (<5 min) and must not be interrupted under any circumstances. In case of an interruption, the software on the DTS 4160 is destroyed and can only be repaired in the factory.

Starting up after an update can also take some minutes (<10 min), or it can result in an additional restart, as the file systems have to be checked first.

To eliminate any mistakes during update procedure, the versions should be verified after the update.

7.3 Updating applications or configurations with FTP

To update individual files such as, e.g. dtsapp, dtsmenu, ntpd, dtsdevice.conf, etc. on the DTS 4160, the following steps are carried out

➔ **all file names are case-sensitive:**

1. Connect a FTP client software to the DTS 4160 e.g. with Explorer enter: **ftp://dts@[IP address]** (as user dts). See also chapter 7.6 FTP connection
2. Change to the directory */ram*.
3. Copy all the files to be updated into the directory */ram*.
4. Close FTP connection.
5. The update procedure can be started on DTS 4160 by selecting the menu '3. Maintenance' ➔ '1. Update software (FTP)' and press ENTER.
The message "Update in progress" appears and at the same time, "Please wait!>" is shown in the command line. All images are copied. The DTS 4160 is automatically restarted on completion of the update.
The Telnet or SSH session has to be restarted.

 **Notice:** The update procedure (point 5) may take longer time depending on the type and number of images (<5 min) and must not be interrupted under any circumstances. In case of an interruption, the software on the DTS 4160 is destroyed and can only be repaired in the factory.

To eliminate any mistakes during update procedure, the versions should be verified after the update.

7.4 Updating images via USB

Possible images are: dts4160_dts4210u-boot, dts4160_dts4210app.ubifs,
dts4160_dts4210rootfs.ubifs, dts4160_dts4210cfg.ubifs,
dts4160_dts4210ulmage, dts4160_dts4210devicetree.dtb.
Additionally the file **dts4160_dts4210check.md5** must exist.

➔ **all file names are case-sensitive.**

Steps for updating images:

1. Copy images to the USB stick
2. Plug the stick in the DTS 4160

 **Important: USB stick plugged in:**

Do **NOT** press the red button, after inserting the USB stick.
Start update, before main display appears again (timeout).

3. The update procedure can be started on DTS 4160 by selecting the menu '3. Maintenance' ➔ '2. Update software (USB)' and press ENTER.
The message "Update in progress" appears and at the same time, "Please wait!>" is shown in the command line. All images are copied. The DTS 4160 is automatically restarted on completion of the update.
The Telnet or SSH session has to be restarted.
4. As soon as the DTS 4160 is restarted, remove the USB stick.

 **Notice:** The update procedure (point 3) may take longer time depending on the type and number of images (<5 min) and must not be interrupted under any circumstances. In case of an interruption, the software on the DTS 4160 is destroyed and can only be repaired in the factory.



Notice: Ensure USB port is configured as “on”.
→ See chapter 6.5.24 General settings

Starting up after an update can also take some minutes (<10 min), or it can result in an additional restart, as the file systems have to be checked first .

To eliminate any mistakes during update procedure, the versions should be verified after the update.

7.5 Updating applications or configurations via USB

To update individual files, e.g. dtsapp, dtsmenu, ntpd, dtsdevice.conf, etc. on the DTS 4160, the following steps are carried out

→ **all file names are case-sensitive, all names with 4160:**

1. Copy applications (or configuration) to the USB stick
2. Plug the stick in the DTS 4160



Important: USB stick plugged in:

Do **NOT** press the red button, after inserting the USB stick.
Start update, before main display appears again (timeout).

3. The update procedure can be started on DTS 4160 by selecting the menu '3. Maintenance' → '2. Update software (USB)' and press ENTER.
The message "Update in progress" appears and at the same time, "Please wait!>" is shown in the command line. All applications are copied. The DTS 4160 is automatically restarted on completion of the update.
The Telnet or SSH session has to be restarted.
4. As soon as the DTS 4160 is restarted, remove the USB stick.



Notice: The update procedure (point 0) may take longer time depending on the type and number of images (<5 min) and must not be interrupted under any circumstances. In case of an interruption, the software on the DTS 4160 is destroyed and can only be repaired in the factory.



Notice: Ensure USB port is configured as “on”.
→ See chapter 6.5.24 General settings

To eliminate any mistakes during the update procedure, the versions should be verified after the update.



Important: USB stick recognition:

After removing the USB stick, wait approx. 1 min. before re-inserting the it again. Otherwise it can be, that the USB stick is not recognized.

7.6 FTP connection

Establish anonymous connection:

ftp://“IP address of DTS 4160”

to directly reach the sub-directory */ram*, e.g. Explorer *ftp://10.241.0.5*

Establish connection as/with a user:

ftp://dts@“IP address of DTS 4160”.

e.g. with Windows Explorer enter: *ftp://dts@10.241.0.5*

Password: **dts** resp. the defined password for the menu.

To directly reach the sub-directory */ram*, you can also enter

ftp://dts@10.241.0.5/ram.

Establish connection with IPv6:

The address **must** be written in brackets []:

e.g. with Explorer enter: *ftp://dts@[fd03:4432:4646:3454::2000]*



Notice: The file has to be copied in binary mode (not ASCII).

FTP tools

	Windows 7, 8, 10, 11	Linux (Suse, Redhat)
Integrated in the system (file manager):	Windows Explorer Start → Execute: Explorer	Konqueror / Dolphin
Programs (examples)	CuteFTP	Kbear

7.7 SFTP connection

SFTP = SSH File Transfer Protocol

SFTP tools

	Windows 7, 8, 10, 11	Linux (Suse, Redhat)
Integrated in the system (file manager):	-	Konqueror / Dolphin
Programs (examples)	WinSCP	-

7.8 SCP connection

SCP = Secure Copy Protocol

Notice: SCP connection can only be established when no menu (operation) is open.

The following error message can be ignored. There is no influence in the functionality of the operation:

```
Command 'groups'  
failed with termination code 127 and error message  
-sh: groups: not found.
```

SCP tools

	Windows 7, 8, 10, 11	Linux (Suse, Redhat)
Integrated in the system (file manager):	-	With command line
Programs (examples)	WinSCP ¹⁾	-

¹⁾ Due to technical restrictions SCP is only supported on command line interface. Use SFTP instead → See chapter 7.7 SFTP connection

7.9 Save Configuration externally

(for backup or copy to another DTS 4150 or DTS 4160)

Save the current configuration via MOBA-NMS:

1. Select DTS device in the device view.
2. Menu 'Edit' → Select 'Backup configuration...'
3. Select the elements that are to be saved. (In case of doubt, select everything)
4. Click button 'Next >'
5. Indicate destination file by clicking the 'Browse...' button.
6. Optionally: enter a free backup comment. E.g. reason for the backup, use, etc. This comment will then be shown during the restoration of the backup.
7. By clicking the 'Finish' button, the backup is created.
8. At the end of the backup, an overview of the process is shown. It shows which elements were saved and which ones are not available or could not be saved.

Save the current configuration via FTP:

1. Connect a FTP client software to the DTS 4160 (with Explorer enter: **ftp://dts@"IP address"**) (as user dts).
2. Change to the DTS 4160 directory **/etc**.
3. Save the file **dts4160.conf** (configuration) to the user PC (e.g. copy the file to the Desktop or to the directory *My Documents*).
4. Additionally also save possible telegram files from the directory **/var/local/dts**.

Save the current configuration via USB-Stick:

The whole procedure can be analogously done with an USB stick. The copy procedure to the USB stick can be started on DTS 4160 by selecting the menu '3. Maintenance' → '3. Backup configuration and log to USB' and press ENTER. All files (including telegram files) will be copied into the root directory of the USB stick.

Copy configuration to another DTS 4150 / DTS 4160:

In order to copy the entire configuration or elements of it from a DTS device to another, the according assistant in MOBA-NMS can be used. For this, select the source device (from which the configuration shall be transferred) and start the assistant in the menu 'Edit' → 'Transfer configuration...'. It will lead you through the individual steps.

Without MOBA-NMS, perform the procedure explained in chapter 7.3 resp. 7.5.

Notice: When copying the configuration from one DTS 4160 to an other, the IP address may have to be changed after the download by serial connection.



7.10 Copying Telegram files to the DTS 4160.grandmaster

Only applicable for DTS 4160 !

Analogously to the previously described procedures telegram files can be copied via FTP or USB stick to the DTS 4160.

The copy procedure can be started on DTS 4160 by selecting the menu '3. Maintenance' → '8. Copy telegram-files' and press ENTER. Afterwards, select again in the menu "6.5.4 Serial interface" and reload.

The files are stored in the directory `/var/local/dts` and can be deleted or copied via FTP.

Special case USB stick:

If the DTS recognizes the insertion of an USB stick, it is shown on the display. By pressing the red button the copy procedure can be released (analogously to the above described procedure). The button has to be pressed until the copy procedure is started.

Management with MOBA-NMS:

With MOBA-NMS, the files do not need to be copied manually via FTP or USB stick, since this is already integrated in the MOBA-NMS operation. At every file selection, the 'Change...' link can be clicked. This opens a file dialog which shows all files and allows new files to be loaded onto the device or existing ones to be deleted.

Example of a program file choice:

Program file: [Change...](#)

Link for opening the file dialog for editing the file list.

Notice: After the file copy procedure, the output of the telegram files are re-started (take over of the files).

Notice: The **file name** is limited to **8 characters** before the dot, e.g. **IF482Std.tel**

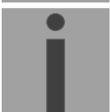

8 Time administration

8.1 Concept of time administration

The internal master clock runs on UTC (Universal Time Coordinated). The time shown on the display as well as some outputs are linked via a time zone entry with the master clock time and can therefore be individually allocated to a specific time zone.

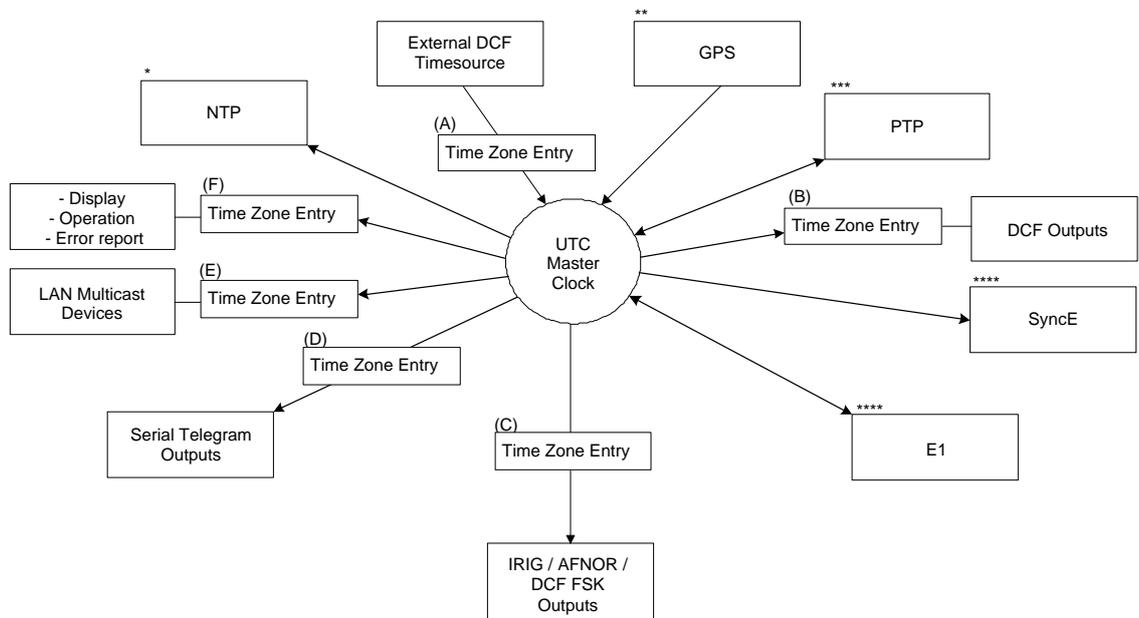

Configurable time zones:

- (A) chapter 6.5.9 Time source
- (B) chapter 6.5.2 DCF – output
- (C) **Only DTS 4160:** chapter 6.5.5 IRIG / AFNOR / DCF-FSK Output
- (D) **Only DTS 4160:** chapter 6.5.4 Serial interface
- (E) chapter 6.5.7 NTP slave clocks / time zone server
- (F) chapter 6.5.24 General settings
- * NTP is always UTC
- ** GPS is always UTC
- *** PTP is always TAI (PTP timescale)
- **** SyncE and E1 contains no local time information

8.2 Synchronization process & diagram

The time that the DTS 4160 maintains is referred to as System time. The System Time is used to supply time to all of the available time of day outputs (such as the front panel LCD display, NTP time stamps, PTP time stamps, etc.).

System time can be synchronized to different time references. All configured sources are monitored simultaneously but the DTS can only synchronize to one source at the time.

Multiple configured sources allow redundancy on time reference side. The following sources are supported:

- GNSS (default)
- Redundant link (between two DTS 4150 or two DTS 4160)
- PTP
- High precision DCF
- E1 (**only DTS 4160**)
- NTP (**only DTS 4150**)

Each source has a user assigned priority that defines the source change process on a source error (e.g. priority 1 source GNSS loses reception. If E1 had priority 2, the DTS would change source and synchronize to E1.)

The flow chart below illustrates how the DTS 4160 synchronizes to the available time sources.

1. On system startup, the DTS waits until the oscillator reaches stable state.
2. Then it waits for an available source to set system time (usually it uses the first source that is available, not necessarily source with priority 1).
3. As soon as system time is within nanoseconds to its source, outputs will be enabled and system time OK flag set.
4. In normal operation (system time set), all configured sources are monitored simultaneously.
5. If the active source suddenly is not available anymore (e.g. due to loss of GNSS reception), the DTS will change its active source to the source with the next lower priority (e.g. from prio 1 to prio 2). DTS will always change back to a higher priority source as soon as one is available (see example situation further below).
Source changes cannot happen more than ones in 10 minutes.
6. If for some reason no source is available, the device goes into holdover mode (based on internal oscillator).
7. The DTS regularly updates its synchronization status based only on the active source. Such contains stratum calculation and synchronization alarms (e.g. Big offset to time source).

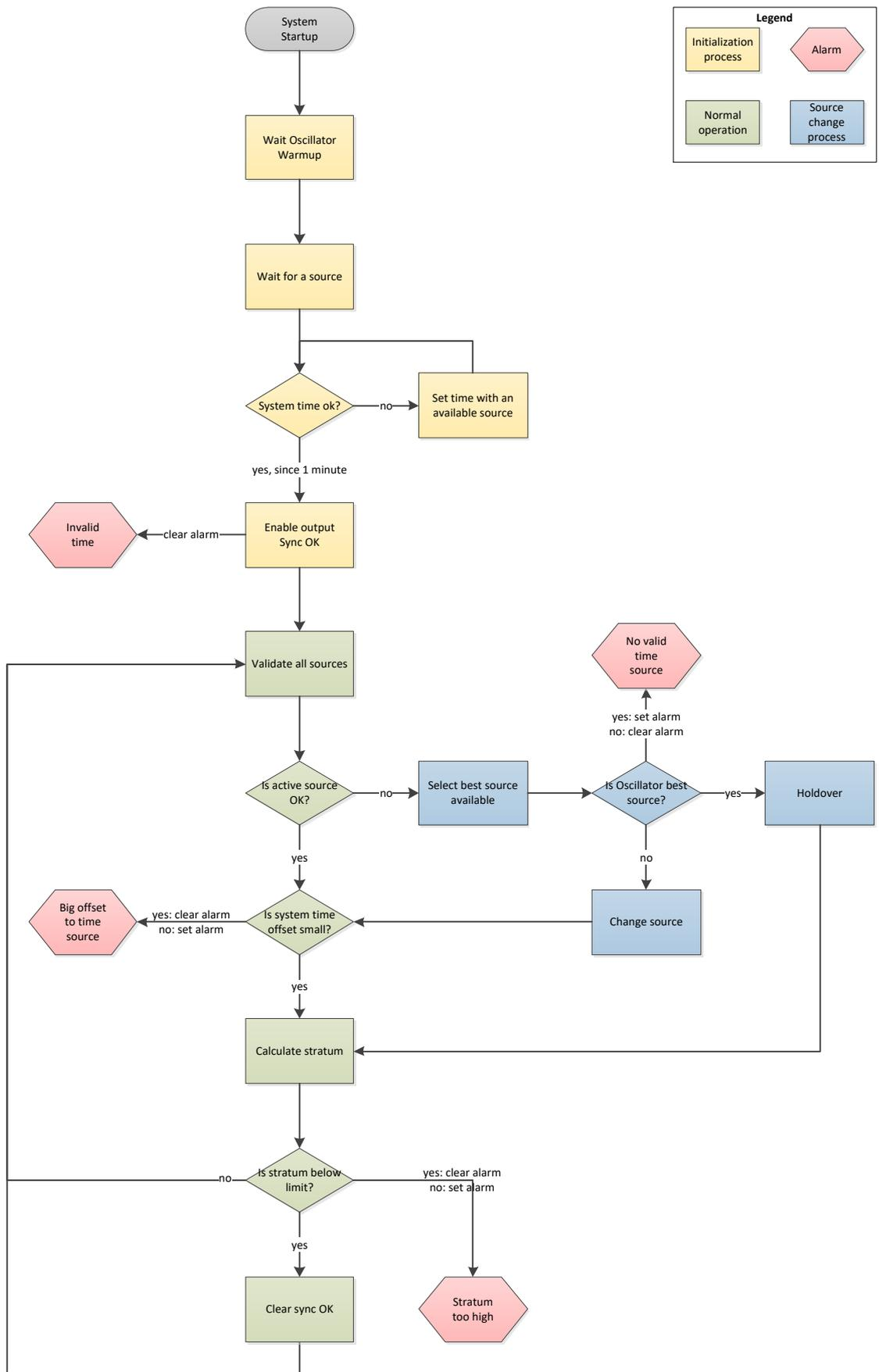

8.3 Time acceptance

System startup:

After finishing the boot procedure, the time reception from any source usually takes 10 minutes or more. The first source available will be taken to set system time even if it does not have priority 1.

Outputs activation:

As soon as the system time was set successfully within nanosecond accuracy to its source, the outputs are activated.

Source changes:

Time source change decisions are either done automatically or manually, depending on user settings.

Automatic mode: The priority is based on deviation estimations of each source. The source with lowest deviation has highest priority.

Manual mode: Uses the user defined source priority list.

Source failures:

The active source is permanently supervised. If it fails for more than 1 minute, DTS will choose the next best source (e.g. from priority 1 to priority 2). Source changes happen immediately but maximal once per 10 minutes, which prevents source hopping.

Holdover accuracy:

The specified holdover accuracy is reached after a minimum of 7 days of continuous synchronization to an accurate source such as GNSS or PTP. The lower the source accuracy, the longer it takes to reach high holdover accuracy. Holdover accuracy increases over time, hence the longer synchronized the higher is the accuracy in holdover.

Short-term time/frequency stability:

When the specified holdover accuracy is reached, a source failure of less than 1 hour has no effect on output accuracy.

Long-term source failure (> 1 hour):

Longer source failure puts the DTS into holdover. When the holdover accuracy is reached, a long-term source failure can be bridged with accuracy according to the built-in oscillator.

At the moment of the resumption of the source signal, a possible time drift is adjusted with a speed of a few ns/sec.

A correction can take up to 1 hour plus 1 hour per day of source absence.

Example: Loss of GPS during 2 days:

Duration of time correction = 1 hour + 2 x 1 hour → Total: approx. 3 hours

Variants of time synchronization:

- Adjusting slowly (Adjust Mode = follow):
After starting the DTS, the time is set for a first time (from a source). Afterwards, the time will only be aligned with maximum adjusting speed of a few ns / sec. if deviating from the source.
Configuration: see chapter "6.5.10 Time adjustment"
- Adjust immediately (Adjust Mode = set): → **this mode is currently not implemented!**

Manual time set:

The time is always set immediately. The stratum is set to 1 or to the defined fix stratum value. All configured outputs will be activated.

8.4 Stratum handling

Stratum in synchronized operation:

The Stratum value behaves as follows for synchronization from the time source:

- When a fix stratum is configured, the system will always have this configured Stratum.
- If the system has auto stratum configured then the system will have the Stratum of its source plus 1. GNSS has Stratum 0 => DTS therefore Stratum 1. A PTP master clock may have Stratum 1 => DTS therefore has Stratum 2.

Stratum in case of time source loss:

The Stratum value behaves as follows in the case of a time source loss:

When a fix Stratum is configured, the system will always have this configured Stratum.
When the Stratum is set to auto mode the Stratum is calculated as follow:

The Stratum can count from 1 up to 16, which means 15 steps

1 hour => 60 minutes => 3600 seconds, $3600 / 15 \text{ steps} = 240 \text{ s/step}$

E.g. the Stratum timeout is configured to 2 hours, the Stratum is increasing:

2h => 120min => 7200 sec

$7200 \text{ sec} / 15 = 480 \text{ s/step} (\rightarrow 8 \text{ min/step})$

Stratum increase is stopped at configured Stratum limit.

E.g. the Stratum timeout is 2 hours (increasing of the Stratum every 8 minutes), the Stratum limit is set to 12. These means after 8 minutes of synchronisation loss the device will increase the Stratum from 1 to 2. 8 minutes later the device will change the Stratum from 2 to 3 and so on. After 11 steps * 8 minutes = 88 minutes the Stratum of the device is 12. From now on the device will have the Stratum 12 until it is synchronized again. The Stratum increase stops, because the device has from now on the synch alarm (as configured).

Technical description of the stratum functionality:

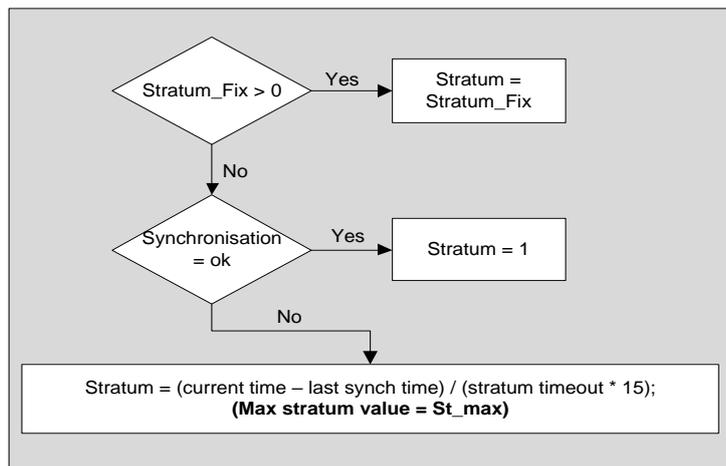

Legend:

Stratum timeout: Stratum TO <0-16>, Stratum error timeout time 1-999 [h], for loss of the source

St_fix: 0..15, configurable fix stratum, 0 = auto

Max Stratum value: 1..16, configurable stratum limit

current time [s]: current time (can be found in the overview => time state)

last synch time [s]: time of the last synchronization (can be found in the overview => time state)

8.5 Source change example situation

For better understanding of how source changes happen, consider the following situation:

- DTS has 3 sources configured: 1. GNSS, 2. PTP, 3. E1.
- Time source change mode is set to manual.
- DTS is powered off, all sources are correctly configured and cables plugged-in.

Now, the DTS is powered on and system starts up. Initial synchronization is done by using PTP time even though it does not have priority 1, but because it's the fastest source available.

10 Minutes after choosing PTP as active source, DTS will change to GNSS, it's priority 1 source.

Further, consider the following scenario:

- Priority 1 source, GNSS, loses reception for more than a minute.
- The sources PTP and E1 are currently available.
- Time source change mode is set to auto.

During DTS uptime all sources are statistically analysed and rated according to an estimated deviation (this means, the more stable a source, the better its rating).

DTS will switch immediately to priority 3 source, E1, because its deviation is lower than the one of PTP (meaning in this scenario: PTP is a less stable source than E1).

After some days, GNSS reception is back. Then after some minutes (10 minutes or more) the DTS time handler estimated GNSS as the best source of all three and switches back to GNSS.

As a last scenario consider the scenario above, but:

- Time source change mode is set to manual.

In manual source change mode the statistical analyzation does not make any source rating. Only the priority list made by the user decides which source will be next on a failure.

On a GNSS failure DTS will now switch to priority 2 source, PTP. E1, as priority 3 source, will be taken if GNSS and PTP fail.

8.6 Time server

- NTP v4 (compatible with v3, RFC 1305) as per RFC 5905 (port 123)
- SNTP (UDP), RFC 4330 (port 123)
- PTP (UDP), IEEE 1588-2019 (V2.1) (ports 319 and 320)
- TIME (TCP/UDP), RFC 868 (port 37)
- DAYTIME (TCP/UDP), RFC 867 (port 13)

8.7 Time accuracy, time-keeping

See appendix G Technical data.

8.8 Leap second

8.8.1 Introduction to the leap second

A leap second is a one-second adjustment that keeps Coordinated Universal Time (UTC) in sync with the earth's rotation. The organization IERS (<http://www.iers.org>) decides within a half year in advance whether a leap second shall be inserted or not. A leap second can be inserted into UTC time twice a year: on 31th of December or on 30th of June.

A leap second may be added or removed.

The organization IERS (<http://www.iers.org>) decides within a half year in advance whether a leap second shall be inserted or not.

8.8.2 Leap second handling by the DTS 4150 and DTS 4160:

The DTS 4160 can be prepared by the following procedures to implement a leap second:

- Manual user input
- Currently used source
- Ignore Leap second

→ A received leap second will be saved, so even when the source is not available in the leap moment the leap second will be done. A saved leap second can only be cleared, when the leap second mode is changed to no leap second.

Manual user input:

To ensure that the leap second adjustment process starts at the exact time the leap second may be configured manually.

In this case the leap second adjustment will be executed at the exact date and time even if the GPS reception is not sufficient.

→ **This procedure is recommended by Mobatime!**

GNSS Receiver:

The GNSS satellite system transmits the information of a Leap Second adjustment at an arbitrary number of months in advance.

Redundant-Link-Mode:

The Redundant-Link provides leap second indication within a 1 hour before occurrence.

PTP and the leap second

PTP provides leap second indication before occurrence, either with the Flag 59 or the Flag 61 depending on the direction of the leap second.

DCF and the leap second

DCF provides leap second indication before occurrence. DCF does not indicate in which direction the leap second is. The DTS 4160 will in case of a leap second announcement from DCF insert a second in the leap moment. This is the only direction which happened so far.

E1 and the leap second

E1 does not have a leap second indication.

8.8.3 Leap second alert notification on DTS 4150 and DTS 4160 outputs

The DTS 4160 announce a pending leap second adjustment by the following methods:

- **NTP Packets** provides leap second indication within at least 1 hour before occurrence
- **PTP Packets** provides leap second indication within at least 1 hour before occurrence
- **Redundant link** provides leap second indication within at least 1 hour before occurrence
- **DCF-Outputs** provides leap second indication within at least 1 hour before occurrence

8.8.4 Leap second correction mode

A Leap Second will be inserted always in one step.

The sequence of dates of the UTC second markers will be as the following (Example end of the year):

```
+1 Second
    December 31, 23h 59m 59s
    December 31, 23h 59m 59s
    January 01, 00h 00m 00s
-1 Second
    December 31, 23h 59m 57s
    December 31, 23h 59m 58s
    January 01, 00h 00m 00s
```

8.8.5 Leap second status indication

The DTS 4160 shows the following information about a leap second

- Leap second status (no Leap Second planned, Leap Second pending)
- Leap second time & date (if pending, otherwise none)
- Leap second adjust direction (-1, +1, if pending)
- Leap Second source (Manual, GNSS, Redundant-Link, PTP, DCF)
- Time & date of last implemented Leap second (since the last reboot)

A Leap Second implementation is also logged in the dts log file (/var/log/dts.log) on the device.

➔ Please see chapter 7.6 how to make an ftp connection to the device.

Implementation in MOBA-NMS

Leap second	
Status:	No leap second detected
Source of leap second:	None
Date of next leap second:	None
Direction of next leap second:	None
Date of last leap second:	None
Direction of last leap second:	None

8.9 NTP Authentication

NTP provides two variants for authentication in version 4:

- NTP symmetric keys (i.e. symmetric keys)
- NTP autokeys

NTP authentication assures a correct time source and prevents manipulation of NTP information. NTP data itself is, however, not encoded.

8.9.1 NTP symmetric keys

A 32-bit key ID and a cryptographic 64/128-bit check sum of the packet is attached to each NTP IP packet.

The following algorithms are used for this purpose:

- Data Encryption Standard (DES)
(partly restricted in North America and no longer integrated into new NTP variants (>V4.2))
- Message Digest (MD5)
- Secure Hash Algorithm (SHA1)

The DTS 4160 supports the MD5 and SHA1 procedure.

The receiving NTP service calculates the check sum with an algorithm and compares it with the one contained in the packet. Both NTP services must have the same encryption key and the same corresponding key ID for this purpose.

Packets with a wrong key or wrong check sum will not be used for synchronization .

The DTS 4160 must be correspondingly configured to be able to use NTP authentication (chapter 6.5.13 NTP). The NTP service of the other equipment (e.g. server, PC...) must also be configured. In the case of standard NTP, this occurs via the `ntp.conf` file:

```
# path for key file
keys /etc/ntp/ntp.keys
trustedkey 1 2 3 4 5 6# define trusted keys
requestkey 4 # key (7) for accessing server variables
controlkey 5 # key (6) for accessing server variables
server ntp1.test.org key 2
server ntp2.test.org key 6
server 192.168.23.5 key 3
```

The description of the `ntp.conf` file can be accessed via the corresponding man-page, or consulted at <http://www.eecis.udel.edu/~mills/ntp/html/authopt.html>

The authentication mode is automatically activated when a key is used and the paths for the keys have been correspondingly configured.

`trustedkey` defines all keys currently permitted

`requestkey` defines the key for the `ntpq` help tool.

`controlkey` defines the key for the `ntpdc` help tool.

The keys are located in the `ntp.keys` file defined with `keys`. This has the following format:

```
1 M TestTest
2 MD5 df2ab658
3 SHA1 2C7DE8F891BEA1904111A802D98053D114CB6FDB
498 M NTPv4.98
```

The key ID is in the first column of the file, the format of the keys in the second defined column, and the key itself in the third. There are four key formats, however the DTS supports only MD5 and SHA1 → M. The letter M is no longer written for new NTP variants (>V4.2) and is only necessary for backwards compatibility. The characters ' ', '#', '\t', '\n' and '\0' are not allowed in the MD5 ASCII key! Key 0 is reserved for special purposes and should therefore not be used here.

ntp.keys: man page for ntp.keys to be noted (check the internet)

8.9.2 NTP Autokey

The validity of the time received to the NTP clients is assured by symmetric keys. For a higher degree of certainty, exchanging the keys used regularly is, however, necessary to obtain protection, e.g. from replay attacks (i.e. attacks in which recorded network traffic is simply played back).

The autokey procedure was introduced as the exchange is very involved in a large network. A combination of group keys and public keys enables all NTP clients to check the validity of the time information which they receive from servers in their own autokey group.

NTP Autokey is relatively complex in its use and studying the functionality is definitely necessary beforehand.

Autokey is described at <http://www.cis.udel.edu/~mills/proto.html> or on the NTP homepage <http://www.ntp.org>.

Autokey is currently defined in an IETF draft.

<https://tools.ietf.org/html/draft-ietf-ntp-autokey-08>

The configuration of Autokey is explained in

<http://support.ntp.org/bin/view/Support/ConfiguringAutokey> or in

<http://www.ntp.org/ntpfaq/NTP-s-config-adv.htm#S-CONFIG-ADV-AUTH>.

8.10 PTP

With the Precision Time Protocol (PTP) it is possible to synchronize an Ethernet Network in sub micro seconds (Nanoseconds). The DTS 4160 supports PTP Version 2.1 as specified in the IEEE 1588-2019 standard. It is available on 3 different network interfaces (see Appendix "A Connection diagrams").

The DTS 4160 can be configured to run as a Grandmaster or Slave. It communicates via the Ethernet ports by sending PTP packets with current time and synchronization information.

Connectors:	Ethernet via 1x SFP and 2x RJ45 referring to Appendix "A Connection diagrams"
PTP Version:	PTP V2.1 according to IEEE 1588-2019, PTP V1 is not supported
Delay Mechanism:	P2P (Peer-to-Peer), E2E (End-to-End)
Transmission mode:	IPv4, IPv6, Layer2, UDP, Multicast and Unicast according to definition IEEE 1588-2019
Master-Slave:	Master and Slave(only Multicast)
Clock Mode:	"2 step" or "1 step"
Profiles:	IEEE 1588 default Profile (E2E and P2P), utility/ IEC/IEEE 61850-9-3, IEEE 802.1AS,ITU-T G8265.1, ITU-T G8275.1, ITU-T G8275.2
SNMP:	no specific PTP SNMP MIB

Every PTP Interface can operate as a master in a different Ethernet network.

Only one PTP interface can be slave.

8.11 Synchronous Ethernet (SyncE)

With SyncE, devices in an Ethernet Network can synchronize their clock to the frequency used to transmit the network packets. The DTS 4160 supports SyncE compatible to ITU G.8262/Y1362. It is available on 3 different network interfaces (see Appendix A Connection diagrams).

The DTS 4160 can be configured to run as a SyncE Master only. It communicates via the Ethernet ports by sending Layer2 packets (ESMC), with the current quality level information.

Connectors: Ethernet via 1x SFP slot and 2x RJ45 ports
referring to Appendix A Connection diagrams

Transmission mode: Layer2

Quality Level: In synchronized state the DTS 4160 sends out the quality level PRC.

8.12 E1

Only applicable for DTS 4160.grandmaster.

For DTS 4160.grandmaster i -> see chapter Appendix H.

E1 is a European digital transmission format specified by the ITU-T. The E1 signal format carries data at a rate of 2.048 Mbit/s. It is composed of 32 channels and the data rate supported by each channel is 64 kBit/s. The DTS 4160 is equipped with one E1 interface.

Outputs: 1x unbalance E1 output (BNC 75 Ohms TX and RX)
1x balanced E1 output (RJ48 jack)

Coded: HDB3 coding format

Features: Supports CRC4

SSM: Only quality level option I (ITU-T G.781/G.704)

DTS 4160 meets the following standards:

G.813: when OCXO IQOV-164 (MV197-B5G @ ≤ Rev 07) is installed

G.812: when OCXO MD-1731-DAT is installed

G.811: when Rubidium is installed and synchronized with GNSS.

8.13 NTP (as time source)

Only applicable for DTS 4150.grandmaster.

With the Network Time Protocol (NTP) it is possible to synchronize a Network client device within an accuracy of milliseconds.

The DTS 4150 supports NTP Versions 3 and 4.

The DTS 4150 can be configured to run as a NTP server or client. It communicates via the Ethernet ports by sending NTP packets with current time and synchronization information.

8.14 Oscillator

Only applicable for DTS 4160 !

The DTS 4160 is available with different types of internal oscillators. The startup behaviour of the Rubidium Oscillator is a bit different from the other oscillators:

- Rubidium :
The rubidium oscillator provides the ability to extend the hold-over period for operation compatible to the G.811 in case off a temporary loss off the time source.

The oscillators are disciplined to the time source available (such as GNSS, PTP, E1...).

During the start-up, the rubidium oscillator has to warm-up. In this warm-up time the oscillator is not stable enough. This is the reason why the device waits for the oscillator to lock/stabilize. This takes normally up to 8 minutes.

For operation with E1 line, the rubidium oscillator is the recommended option.

8.15 Redundant operation of 2 DTS 4150 or 4160.grandmaster

For redundant operation two DTS 4160 devices are synchronized via optical fibres. For this purpose, a mini GBIC module is plugged into both devices and connected via optical fibres (see Appendix G Technical data):

mini GBIC module

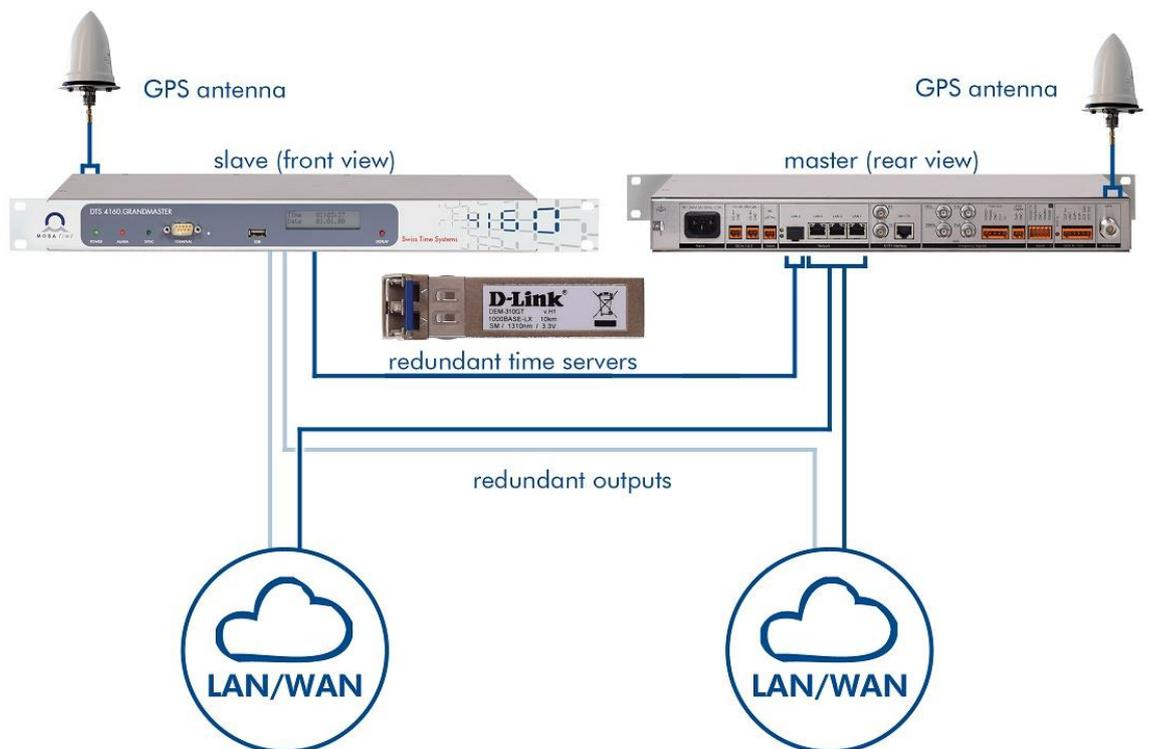

In this scenario both devices have a GPS receiver (GNSS source priority 1). Both devices are configured for the redundant mode (red. link source priority 2), but are basically equal and work out the master/slave role among themselves. The slave supervises the system time on the basis of its own GPS time and generates an error message, should the time difference amount exceed the configurable value of n nanoseconds.

- Starting the devices with fibre optic connection
The devices work out among themselves which is the master (normally the one synchronized first)
- Both devices are always synchronized from GPS
Both devices show the same stratum level (usually stratum 1).
The fibre optic connection is only used for status exchange and time compare.
- In case of loss of the master GPS, the master checks if the slave is better synchronized. If the slave is better synchronized the slave takes over the master

role (only in case it is still synchronized to its own GPS). The previous master becomes the slave and is synchronized via optical link from master. At this point the stratum of the slave is: master stratum +1.

- In case of loss of the slave GPS, the slave is synchronized via optical link from master. Stratum is increased to master stratum +1.
- In the case of a loss of the master (power down), the slave assumes the master function.
- If the former master is working again, it takes the current time from GPS, compares with the current master and remains in slave mode. (Initially it will take the time from redundant link; first source which is locked is used to set the time.)
- In the case of a fibre optic connection loss and both devices are still GPS synchronized, the master remains in master mode and the slave changes from slave to master mode. But both devices release an alarm.

NTP

The NTP clients select the server with the better (lower) stratum.

PTP

Clients use BMCA (Best Master Clock algorithm)

RTC:

It is recommended to not use the RTC.



Notice: If redundant mode is in use, either leave network settings of **port 4** on default values or at least switch DHCP = ON, PTP = OFF and SyncE = OFF.

8.16 Logfile Synchronization status

The DTS 4160 provides a logfile under `/ram/date-wd.log` (e.g. `/ram/20200614-Wed.log`) about the synchronization status seven days back. The Log interval is 1 minute. The maximum value of this 1 minute is written to the file.

Example:

Date&Time	UTC	Offset GNSS	Offset PTP	Offset NTP	Offset DCF	Offset Red.	Offset E1
141118	000000	0 ()	104 (+)	0 ()	0 ()	96 (*)	0 ()
141118	000001	0 ()	104 (+)	0 ()	0 ()	96 (*)	0 ()
141118	000002	0 ()	104 (+)	0 ()	0 ()	96 (*)	0 ()

(*) = active source

➔ Please see chapter 7.6 how to make an ftp connection to the device.

9.1 General

The SNMP version **V2c** or **V3** for *Get*, *Set* and **V1** or **V2c** for *Notification* (Trap) is used. A full SNMP agent is implemented on the DTS (MIB II, DTS4160).



Notice: For detailed SNMP parameters please refer to MIB file. See also end of this page.

For SNMP V2c, following standard *Communities* are used:

Read only:	<i>romobotime</i>
Read/Write:	<i>rwmobotime</i>
Trap:	<i>trapmobotime</i>

For SNMP V3, following standard *User / Passwords* are used:

<i>dtsUser1</i>	<i>mobatime</i>	
<i>dtsUser2</i>	<i>mobatime</i>	
<i>dtsInfo</i>	<i>mobatime</i>	<i>(not changeable, read only)</i>

DtsUser1 and dtsUser2 have full read/write access on all objects. With SNMP V3 rules, access can be reduced. Changes of the rules can only be modified over the DTS menu and not via SNMP.

SNMP V3 agent supports user validation (authentication MD5) and encoding (encryption DES).

MIB II values like sysDescr, sysContact, sysName, or sysLocation can only be modified over the DTS menu but not via SNMP.

The following MIB definitions are used:

SNMPv2-SMI, SNMPv2-MIB, SNMPv2-CONF, SNMPv2-TC, SNMPv2-TM, SNMP-FRAMEWORK-MIB, SNMP-MPD-MIB, SNMP-NOTIFICATION-MIB, SNMP-TARGET-MIB, SNMP-USER-BASED-SM-MIB, SNMP-VIEW-BASED-ACM-MIB, RFC1213-MIB, IF-MIB, IP-MIB, IP-FORWARD-MIB, TCP-MIB, UDP-MIB, HOST-RESOURCES-MIB, HOST-RESOURCES-TYPES, DISMAN-EVENT-MIB, NOTIFICATION-LOG-MIB, UCD-SNMP-MIB, NET-SNMP-MIB, NET-SNMP-TC

SNMP V2c, V3:

DTS-COMMON (File: DTS-COMMON-MIB.TXT)

General DTS definition, always required

DTS4160 (DTS4160-MIB.TXT)

Device-specific DTS definitions

MIB-Files copy from DTS device:

The MIB files can be copied from the DTS 4160 with FTP (For FTP use, see chapter “7.6 FTP connection“):

DTS-MIB: */etc/snmp/mibs/*

Standard MIBS: */usr/share/snmp/mibs/*

9.2 Device configuration with SNMP

**Most of the SNMP commands / fields are valid for DTS 4150 and 4160.
For DTS 4150 simply replace 4160 -> 4150.
Details are available in the MIB files of each device.**

If one or several variables are set in a configuration group with *Put*, the variable *dts4160????ConfigCmd* must be set at the end to 1 in the corresponding group. The values of the entire configuration group are assumed from the DTS with this command (1=Save).

As long as the accept command has not been set, the changed variables can be restored to the old values by setting the *dts4160????ConfigCmd* variable to 2 (2=undo, restore).

After sending the accept command, a *dts4160ConfigChanged Notification* is sent.

The definitions of the available variables can be taken from the MIB files.

Example:

Management-System		DTS
<i>Put</i> dts4160FTPMODE=1	→	Variable is set to 1 internally
<i>Put</i> dts4160NetServicesConfigCmd=1	→	Configuration group is assumed
	←	Sends <i>dts4160ConfigChanged Notification</i> with the new time <i>dts4160NetConfigChangedTime</i>

9.3 DTS subagent SNMP notification

Protocol: SNMPv2c Notification

For *Notifications* to be sent out, SNMP must be switched on. In addition, at least one receiver system must be configured.

9.3.1 Startup

[dts4160StartUp]

Sent out when the subagent for the DTS is started.

This *Notification* is always sent out, as soon as SNMP is activated and a destination address is configured.

9.3.2 Shutdown

[dts4160Shutdown]

Sent out when the subagent for the DTS is stopped.

This *Notification* is always sent out, as soon as SNMP is activated and a destination address is configured.

9.3.3 Status changed

[dts4160StatusChanged]

Sent out when the subagent detects a status change in the DTS application process. The following variables are monitored for changes:

dts4160SysStatus, dts4160NTPTInfoCurrentSource, dts4160SysStratum

This *Notification* is always sent out, as soon as SNMP is activated, and a destination address is configured.

The *Notification* sent out contains the following data:

Field	Type	Size	Description	Example
dts4160SysStatus	Unsigned Int	4 Bytes	Contains the internal system status	66309
dts4160TimeInfoSourceOffsetN Sec	Integer	4 Bytes	Actual time offset of the system [ns]	-28 → -28ns
dts4160TimeInfoStratum	Byte	1 Byte	Actual system stratum level	2
dts4160TimeInfoTimeSource	Byte	1 Byte	Actual time source	1

9.3.4 Configuration changed

[dts4160ConfigChanged]

Sent out when the subagent detects a configuration change in the DTS application processes.

This *Notification* is always sent out, as soon as SNMP is activated and a destination address is configured.

The *Notification* sent out contains the following data:

Field	Type	Size	Group
dts4160SysConfigChangedTime	TimeTicks	4 Bytes	dts4160System
dts4160NetworkPortConfigChangedTime	TimeTicks	4 Bytes	dts4160NetworkPortEntry
dts4160NetworkLAGIFConfigChangedTime	TimeTicks	4 Bytes	dts4160NetworkLAGIFEntry
dts4160NetworkIPCfgConfigChangedTime	TimeTicks	4 Bytes	dts4160NetworkIPCfgEntry
dts4160NetworkVLANConfigChangedTime	TimeTicks	4 Bytes	dts4160NetworkVLANCfgEntry
dts4160NetServicesConfigChangedTime	TimeTicks	4 Bytes	dts4160NetServices
dts4160TSConfigChangedTime	TimeTicks	4 Bytes	dts4160TimeSource
dts4160RedundantLinkConfigChangedTime	TimeTicks	4 Bytes	dts4160TimeRedundantLink
dts4160NTPConfigChangedTime	TimeTicks	4 Bytes	dts4160TimeNTPServer
dts4160PTPConfigChangedTime	TimeTicks	4 Bytes	dts4160TimePTPConfig
dts4160GNSSConfigChangedTime	TimeTicks	4 Bytes	dts4160TimeGNSSConfig
dts4160DCFINConfigChangedTime	TimeTicks	4 Bytes	dts4160TimeDCFINConfig
dts4160OutMainDCFCfgConfigChangedTime	TimeTicks	4 Bytes	dts4160OutMainDCF
*dts4160OutLinePulseFREQConfigChangedTime	TimeTicks	4 Bytes	dts4160OutLinePulseFREQ
*dts4160OutLineSerialConfigChangedTime	TimeTicks	4 Bytes	dts4160OutLineSerial
*dts4160OutLineIRIGConfigChangedTime	TimeTicks	4 Bytes	dts4160OutLineIRIG
*dts4160OutLineE1ConfigChangedTime	TimeTicks	4 Bytes	dts4160OutputLinesE1
dts4160OutLineTZServerConfigChangedTime	TimeTicks	4 Bytes	dts4160OutLineTZServer
dts4160RelayConfigChangedTime	TimeTicks	4 Bytes	dts4160AlarmRelayConfig
dts4160MailConfigChangedTime	TimeTicks	4 Bytes	dts4160AlarmMailConfig
dts4160SnmpConfigChangedTime	TimeTicks	4 Bytes	dts4160SnmpConfig
dts4160SnmpV3ConfigChangedTime	TimeTicks	4 Bytes	dts4160SnmpV3

* *this fields are only available for DTS 4160*

The *ConfigChangedTime* variables show the time of the last change of the relevant configuration group as TimeTicks value in 1/100th seconds. The management system can decide on the basis of these time values, which configurations need to be reloaded.

9.3.5 Alive Notification

[dts4160Alive]

Sent out in a configurable interval.

This *Notification* is always sent out, as soon as SNMP and the alarm traps are activated and a destination address is configured.

The *Notification* sent out contains the following data:

Field	Type	Size	Description	Example
dts4160SysStatus	Unsigned Int	4 Bytes	Contains the internal system status	66309
dts4160SysAlarms	Byte Array	8 Bytes	64 Bit Alarm flags 1.Byte Bit 0..7 2.Byte Bit 8..15 :: 8.Byte Bit 56..63	FFF870FF.FFFFFFFF 5.Byte 2.Byte 1.Byte

9.3.6 Alarm Notification

[dts4160Alarm]

Sent out if alarm status changes, i.e. *Notification* is sent out when an alarm flag is set or deleted.

This *Notification* is always sent out, as soon as SNMP and the alarm traps are activated and a destination address is configured.

The *Notification* sent out contains the following data:

Field	Type	Size	Description	Example
dts4160TrapAlMsgErrorNr	Byte	1 Byte	No. of the alarm bit (0..63)	3
dts4160TrapAlMsgErrorState	Byte	1 Byte	0 = alarm bit was deleted 1 = alarm bit was set	1
dts4160TrapAlMsgErrorTime	Unsigned Int	4 Bytes	PC-time in seconds since 01.01.1970 00:00:00	946684805
dts4160TrapAlMsgErrorText	Text	59 Bytes	Error text	Failure supply 1

10 Redundant Power supply

The DTS 4160 permits different power supply alternatives:

1. Non-redundant power supply:

Only one power connector is plugged in (24VDC or 240VAC)



Notice: In the menu: '2 Configuration' → '4 General' → '3 Power' must be set to '0=single'.

2. Redundant power supply:

More than one power connector is plugged in.

To guarantee a full surveillance of the inputs, following variants are possible:

		Supply1:	Supply2:
DTS 4150 and 4160:	Variant 1	Mains supply	DC in 1
Only DTS 4160:	Variant 2	Mains supply	DC in 2
Only DTS 4160:	Variant 3	DC in 1	DC in 2

Supply is checked once per minute for correct functioning. The alarm 03: 'Failure red. supply' is set in case of error.



Notice: In the menu: '2 Configuration' → '4 General' → '3 Power' must be set to '1=redundant'.

DTS 4160



DTS 4150



Notice: All power supply inputs are working and can be used regardless of the configuration. The configuration advises the DTS to supervise both power supplies and generate a possible alarm.

DTS 4160c.grandmaster 2x eDC



Special version of the DTS 4160 with 2 galvanically separated DC inputs 24 – 68VDC.

A Connection diagrams

A.1 Front connections

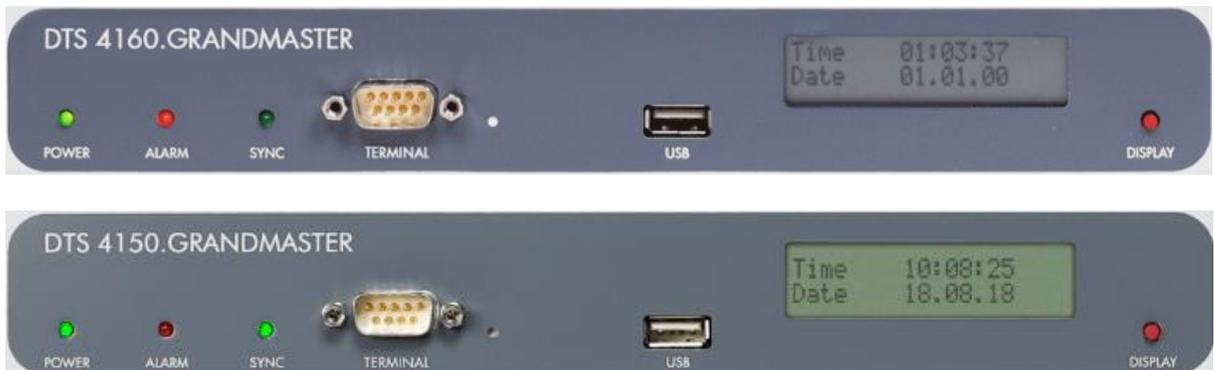

PC - Terminal Connection:

Type of connector: Sub-D 9p connector (male)
 Interface: RS232
 Baud rate: 38400 Bauds
 Data Bits: 8
 Parity: no
 Stop Bit: 1
 Flow control: no

Cable DTS 4150 / 4160 – PC:

(DTE-DTE) Crossed cable, female – female connectors (null modem)
 Max. length of the connection 3m

Connections between female connector 1 (SUB-D 9 / 1) and female connector 2 (SUB-D 9 / 2):

	SUB-D 9 / 1	SUB-D 9 / 2	
Receive Data *	2	3	Transmit Data
Transmit Data *	3	2	Receive Data
Data Terminal Ready	4	1 & 6	Data Set Ready & Carrier Detect
System Ground *	5	5	System Ground
Data Set Ready & Carrier Detect	1 & 6	4	Data Terminal Ready
Request to Send	7	8	Clear to Send
Clear to Send	8	7	Request to Send

* At least needed connections.

USB connection:

Plug: USB host

Notice: Only permitted for operations with a USB stick!



A.2 Connections (rear view)

DTS 4150 connections

For technical data, see appendix “G Technical data“.



DTS 4160 connections

For technical data, see appendix “G Technical data“.

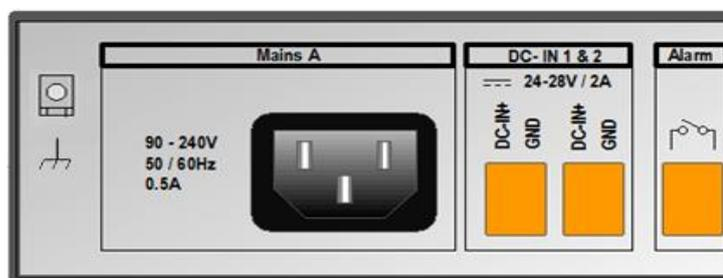

DTS 4150 and DTS 4160

Clamp	Connection	Description
	Mains A	Redundant mains input A (90 – 240 VAC or 80 – 240 VDC)
1	DC in 1 power supply +	Input for external DC supply (24 – 28V)
2	DC in 1 power supply GND	Ground

Only DTS 4160:

3	DC in 2 power supply +	Input for external DC supply (24 – 28V)
4	DC in 2 power supply GND	Ground

DTS 4150 and DTS 4160:

5	Alarm relay	Alarm contact, open when alarm is active
6	Alarm relay	Switching load: 30 W (125 VDC or 1 A), e.g. 1 A @ 30 VDC or 60 VA (150 VAC or 1 A), e.g. 0.5 A @ 120 VAC
	Chassis ground	Ground lug The DTS 4150 and DTS 4160 must be connected to an earth ground via the chassis ground lug

Only DTS 4160c.grandmaster 2x eDC:

1	DC in 1 power supply Minus	Input for external DC supply (24 – 68V)
2	DC in 1 power supply Plus	separately galvanically isolated
3	DC in 2 power supply Minus	Input for external DC supply (24 – 68V)
4	DC in 2 power supply Plus	separately galvanically isolated

DTS 4150:

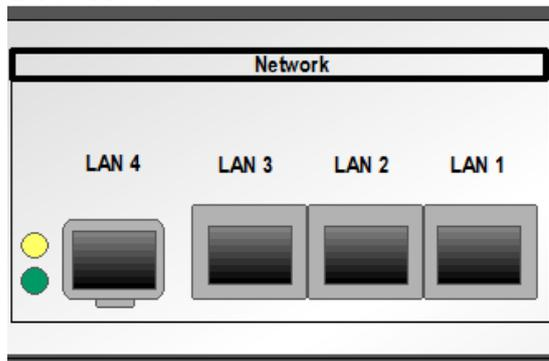

DTS 4160:

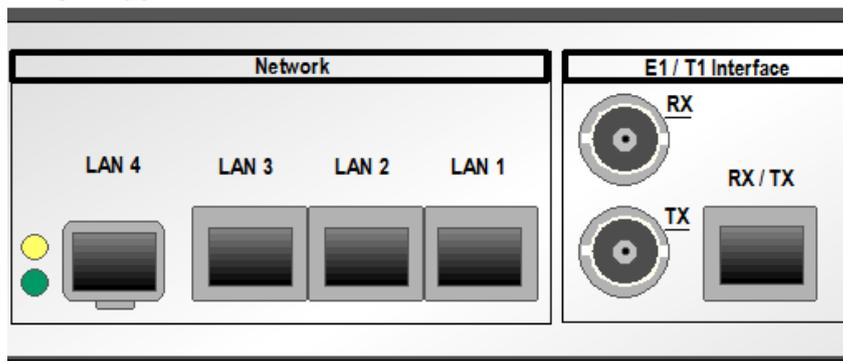

The LAN Interfaces support the following specifications

	100/1000MBit	SFP	NTP / SNTP	SyncE	PTP 2-Step	PTP 1-Step	Configuration Supervision (SNMP, Telnet, SSH)	Redundant Link to other DTS 4150 or 4160	Multiple IP addresses	802.3ad LAG	802.1Q tagged VLAN	802.1p prioritized VLAN
LAN1	√		√				√		√		√	√
LAN2	√		√	√	√	√	√		√		√	√
LAN3	√		√	√	√	√	√		√	√	√	√
LAN4		√	√	√	√	√		√	√		√	√

Only DTS 4160:

Section	Connection	Description
E1 Interface	BNC female RX	E1 signal Receive (75 Ohms)
	BNC female TX	E1 signal Transmit (75 Ohms)
	RJ48	E1 (Pin 1,2 = RX, Pin 4,5 = TX, 120 Ohms)

DTS 4150:



DCF Out	DCF output + DCF output -	DCF output, "current loop" passive, $U_{max} = 30VDC$, $I_{on} = 10..15mA$, $I_{off} < 1mA$ @20VDC
DCF In	DCF input + GND Sup + Sup -	DCF current loop input for the connection of a GPS4500 DC output 28 VDC, max. 100mA (or according to the DC in voltage)
Antenna	GPS	SMA-Female connector (see chapter A.3 Installation instruction GPS antenna)

DTS 4160:

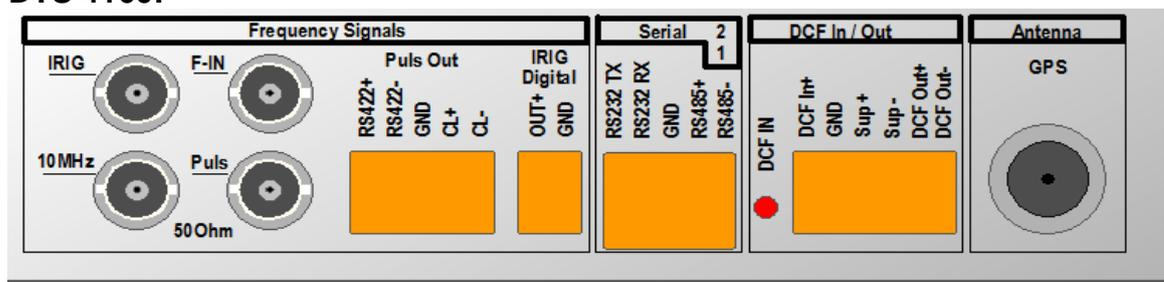

Section	Connection	Description
Frequency Signals	BNC female IRIG	AFNOR-A/C, IRIG-B1xx and DCF-FSK output (analog)
	BNC female 10MHz	10MHz frequency output (50 Ohms)
	BNC female F-IN	Frequency input (50 Ohms)
	BNC female Puls	Pulse output (50 Ohms)
	Puls Out RS422+	RS422 output line for pulse and frequency output
	Puls Out RS422-	
	Puls Out GND	
	Puls Out CL+	Pulse output, "current loop" passive, $U_{max} = 30VDC$, $I_{on} = 10..15mA$, $I_{off} < 1mA$ @20VDC
	Puls Out CL-	
	IRIG Digital OUT+	AFNOR-A/C, IRIG-B00x for unmodulated IRIG output (digital, 50 Ohms, TTL)
IRIG Digital GND		
Serial 1-2	RS232 TX	RS232 interface
	RS232 RX	
	GND	
	RS485+	RS485 interface
	RS485-	
DCF Out	DCF output + DCF output -	DCF output, "current loop" passive, $U_{max} = 30VDC$, $I_{on} = 10..15mA$, $I_{off} < 1mA$ @20VDC

DCF In	DCF input +	DCF current loop input for the connection of a GPS4500
	GND	
	Sup + Sup -	DC output 28 VDC, max. 100mA (or according to the DC in voltage)
Antenna	GPS	N-Female connector (see chapter A.3 Installation instruction GPS antenna)

A.3 Installation instruction GPS antenna

A.3.1 Positioning and assembly of the antenna and EMP protector

The active antenna should be placed in an upright position, with open view to the sky. The minimum viewing angle for correct functioning is 90°.

With a viewing angle of less than 90°, it is to be expected that the device will not be able to receive a signal at all times of day.

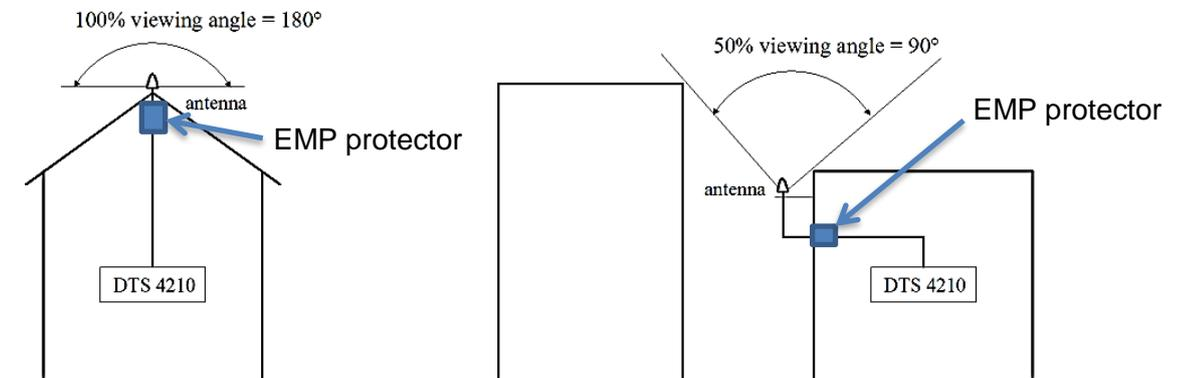

The antenna should only be mounted using the mounting fixtures provided.

The EMP protector shall be mounted just after the entrance of the antenna cable into the building.

The Earthing:

The earth of the EMP protector should be connected to the building's earth system (ground), the same earth (potential) where you connect metallic parts on the roof.

Cross section of the earth cable:

Up to 3m distance and with flex cable, 2.5 mm² is OK. For longer distance, 4 mm² or even 6 mm² flex earth cable should be used.

A.3.2 Installation of the lightning protection (EMP protector)

All dimensions in millimetres (mm)

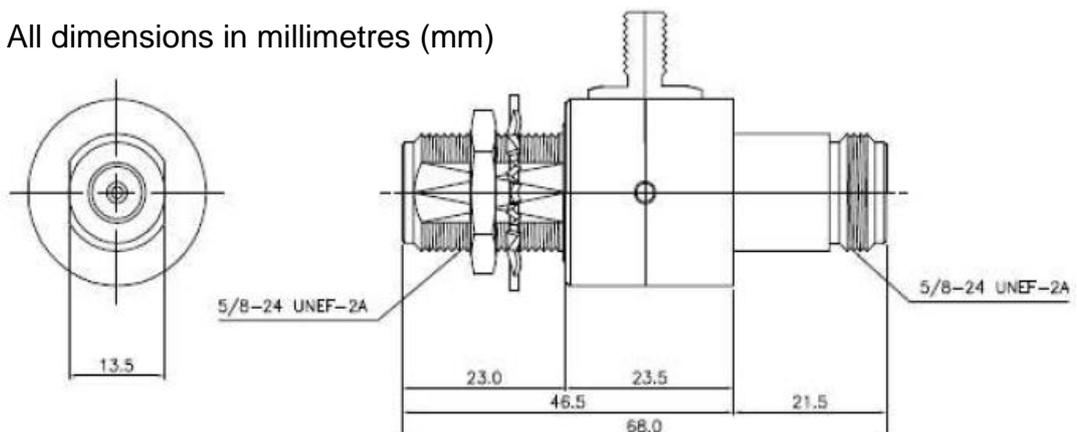

A.3.3 Distance between antenna and DTS 4160

The maximal cable length depends on the attenuation of the cable. The attenuation between the DTS 4160 and the antenna shouldn't be bigger than the gain of the antenna.

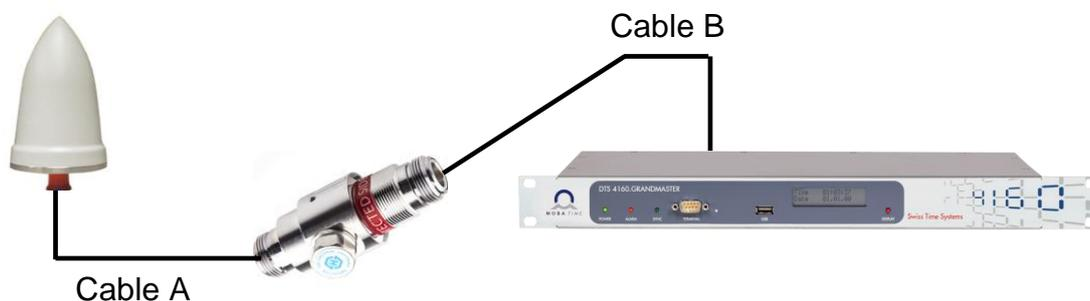

The minimum amplifier gain of the PC-Tel active antenna GPSGL-TMG-SPI-40N is 36 dB (40 dB +/-4 dB) for GPS and 34 dB (38 dB +/-4 dB) for GLONASS. In the table below, the maximal cable lengths are calculated with the minimum amplifier gain. The attenuation of the lightning protector is ≤ 0.2 dB.

The maximum cable length for specific cable types (manufacturer Huber+Suhner) are listed in the table below.

Antenna	PC-Tel GPSGL-TMG-SPI-40N		
Cable type	Attenuation [dB / m]	Cable A + Cable B GPS [m]	Cable A + Cable B GLONASS [m]
RG 58 C/U	0.95	37	35
SPUMA 195	0.51	71	67
SPUMA 400	0.17	212	200

The length of Cable A plus Cable B shouldn't exceed the maximum length from the table.



Notice: Every additional cable adapter attenuates the signal. A typical attenuation of a SMA to N jack adapter is about 0.1 dB

A.3.4 Inline Amplifier

An inline amplifier is required whenever GPS antenna cable lengths cause greater than 36 dB attenuation. The inline amplifier should be placed after the lightning protection. With the inline amplifier the maximum length of the cable can be increased.

For example the inline amplifier TW127 from Tallysman can be inserted.

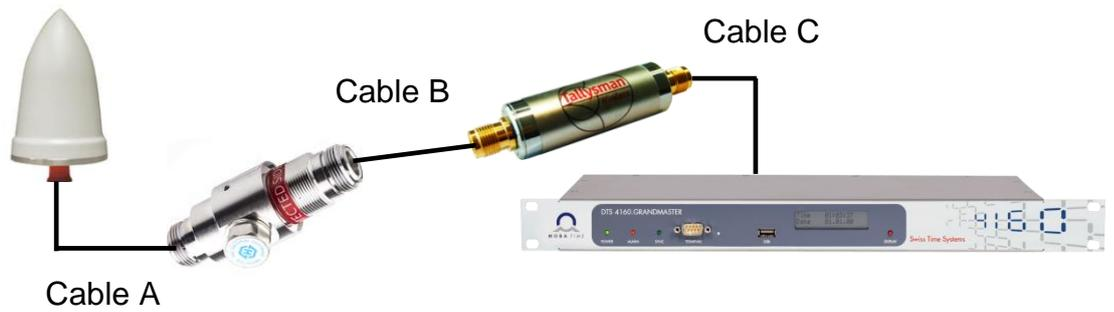

The loss of Cable A plus Cable B should not exceed 36 dB.
 Cable C should not exceed an attenuation of 21 dB.

E.g. Cable type RG 58 C/U: Cable A plus Cable B should not be longer than 37 m.
 Cable C should not exceed 26 m

Inline Amplifier: Tallysman TW127	
Nominal gain	25 dB +4 / -0 dB typ.
Impedance	50 Ohms
Noise figure	2 dB typ.
Operation bandwidth	1559 - 1610 MHz
Supply range voltage	3 to 10 VDC nominal
Supply current	10 mA typ, 15 mA max.



Notice: We recommend, to use the inline amplifier early enough, because it amplifies the received signal. The better the received signal is, the better is the amplified one. In the end Cable A + Cable B + Cable C can use the 36dB from the antenna and the 21 dB from the inline amplifiere, but we do not recommend, that Cable A and Cable B use the whole 36 dB from the antenna.

Technical data

DTS 4150		
Receiver Features GNSS-Module	Module	u-blox MAX-M8
	Frequencies	GPS, GLONASS, GALILEO, BEIDOU:
	Channels	max. 72 satellites trackable
	Frequency accuracy	GNSS locked < 5ppb Hold-over, 24h < 100ppb max.

DTS 4160		
Receiver Features GNSS-Module	Module	u-blox LEA-M8F
	Frequencies	GLONASS, GPS: L1
	Channels	max. 72 satellites trackable
	Frequency accuracy	GNSS locked < 5ppb Hold-over, 24h < 100ppb max.

PC-Tel active antenna GPSGL-TMG-SPI-40N		
Electrical Specifications	Amplifier gain	40 dB +/-4 dB for GPS L1 38 dB +/-4 dB for GLONASS L1
	Connector	Impedance 50 Ohms Type N female
Mechanical Specifications	Material	milky white; UV-resistant plastic
	Dimensions	Ø 81 x H 184 mm (without bracket)
	Protection	IP 67
Environmental Specifications	Temperature range	-40°C to 85°C
	Weight	650g (without mounting kit)
	Humidity	95%

For complete antenna data sheet please see:
http://www.antenna.com/apg_products.cgi?id_num=11209

Tallysman active antenna TW3742-N		
Electrical Specifications	Amplifier gain	38 dB +/-2 dB
Connector	Impedance	50 Ohms
	Type	N female
Mechanical Specifications	Material	milky white; UV-resistant plastic
	Dimensions	Ø 66.5 x H 21 mm (without bracket)
	Protection	IP 67
Environmental Specifications	Temperature range	-40°C to 85°C
	Weight	150g (without mounting kit)
	Humidity	95%

For complete antenna data sheet please see:

https://www.tallysman.com/app/uploads/2019/06/TW3740_TW3742_Datasheet_rev2_9.pdf

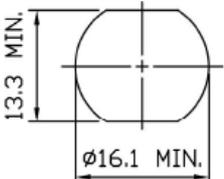
Lightning protection: Type 10800301A-230V / N		
Electrical Specifications	Impedance	50 Ohms
	Connectors	N female
	Surge current handling capability	5 kA (5 times) (8/20 μ s test pulse) 200A (50 times) (10/1000 μ s test pulse)
	Insertion loss	≤ 0.5 dB
Mechanical Specifications	Connectors	Port 1: unprotected , N jack female Port 2: protected , N jack female
	Mounting hole	Min. 16.1 mm 
Environmental Specifications	Temperature range	-40°C to +85°C
	Protection	IP65 (according to IEC 60529, data refer to the coupled state)

Requirements for general active antennas

Frequencies	GPS L1, GLONASS L1
Impedance	50 Ohms
Amplifier gain	The active antenna must amplify the signal to compensate the signal loss in RF cable and lightning protection. E.g. Antenna is connected with two cables and the lightning protection. Cable A 10 m RG 58 C/U Cable B 10 m RG 58 C/U Total attenuation 19.2 dB (referring to the table on the previous page) Minimal amplifier gain 19.2 dB
Maximum noise figure	1.5 dB
Polarization	Right hand circular
Operating DC voltage	5V
Max. current	100mA (with inserted inline amplifier 85mA)

A.4 Plug-in spring terminals

Multiple contact strip 100% protected against wrong plug;
WAGO CAGE CLAMP®-connection
Cross section of 0,08 mm² to 1,5 mm² (from AWG 28 to AWG 14)
Voltage CSA 300 V / current CSA 10 A
Rated voltage: EN 250 V
Rated surge voltage: 2,5 kV
Nominal current: 10 A
Strip length: 7 mm (0,28 in)

Pulled off spring terminal with operation tool:

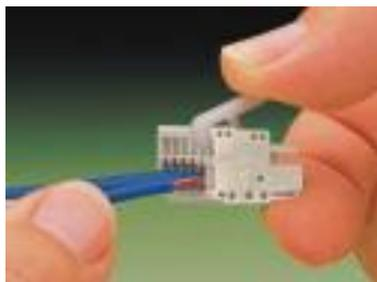

2 operation tools are delivered with the accessory bag.

B Time zone table

Time zone entries in the standard season table (version 10.2).

No.	City / State	UTC Offset	DST	Standard → DST	DST → Standard
00	UTC (GMT), Monrovia	0	No		
01	London, Dublin, Lisbon	0	Yes	Last Sun. Mar. (01:00)	Last Sun. Oct. (02:00)
02	Brussels, Amsterdam, Berlin, Bern, Copenhagen, Madrid, Oslo, Paris, Rome, Stockholm, Vienna, Belgrade, Bratislava, Budapest, Ljubljana, Prague, Sarajevo, Warsaw, Zagreb	+1	Yes	Last Sun. Mar. (02:00)	Last Sun. Oct. (03:00)
03	Athens, Helsinki, Riga, Tallinn, Sofia, Vilnius	+2	Yes	Last Sun. Mar. (03:00)	Last Sun. Oct. (04:00)
04	Bucharest	+2	Yes	Last Sun. Mar. (03:00)	Last Sun. Oct. (04:00)
05	Pretoria, Harare, Kaliningrad	+2	No		
06	Amman	+2	Yes	Last Thu. Mar. (23:59)	Last Fri. Oct. (01:00)
07	UTC (GMT)	0	No		
08	Istanbul, Kuwait City, Minsk, Moscow, Saint Petersburg, Volgograd	+3	No		
09	Praia, Cape Verde	-1	No		
10	UTC (GMT)	0	No		
11	Abu Dhabi, Muscat, Tbilisi, Samara	+4	No		
12	Kabul	+4.5	No		
13	Adamstown (Pitcairn Is.)	-8	No		
14	Tashkent, Islamabad, Karachi, Yekaterinburg	+5	No		
15	Mumbai, Kolkata, Chennai, New Delhi, Colombo	+5.5	No		
16	Astana, Thimphu, Dhaka, Novosibirsk	+6	No		
17	Bangkok, Hanoi, Jakarta, Krasnoyarsk	+7	No		
18	Beijing, Hong Kong, Singapore, Taipei, Irkutsk	+8	No		
19	Tokyo, Seoul, Yakutsk	+9	No		
20	Gambier Island	-9	No		
21	South Australia: Adelaide	+9.5	Yes	1 st Sun. Oct (02:00)	1 st Sun. Apr. (03:00)
22	Northern Territory: Darwin	+9.5	No		
23	Brisbane, Guam, Port Moresby, Vladivostok	+10	No		
24	Sydney, Canberra, Melbourne, Tasmania: Hobart	+10	Yes	1 st Sun. Oct. (02:00)	1 st Sun. Apr. (03:00)
25	UTC (GMT)	0	No		
26	UTC (GMT)	0	No		
27	Honiara (Solomon Is.), Magadan, Noumea (New Caledonia)	+11	No		
28	Auckland, Wellington	+12	Yes	Last Sun. Sep. (02:00)	1 st Sun. Apr. (03:00)
29	Majuro (Marshall Is.), Anadyr	+12	No		
30	Azores	-1	Yes	Last Sun. Mar. (00:00)	Last Sun. Oct. (01:00)
31	Middle Atlantic	-2	No		
32	Brasília	-3	Yes	3 rd Sun. Oct. (00:00)	3 rd Sun. Feb. (00:00)
33	Buenos Aires	-3	No		
34	Newfoundland	-3.5	Yes	2 nd Sun. Mar. (02:00)	1 st Sun. Nov. (02:00)
35	Atlantic Time (Canada)	-4	Yes	2 nd Sun. Mar. (02:00)	1 st Sun. Nov. (02:00)
36	La Paz	-4	No		
37	Bogota, Lima, Quito	-5	No		
38	New York, Eastern Time (US & Canada)	-5	Yes	2 nd Sun. Mar. (02:00)	1 st Sun. Nov. (02:00)
39	Chicago, Central Time (US & Canada)	-6	Yes	2 nd Sun. Mar. (02:00)	1 st Sun. Nov. (02:00)

40	Tegucigalpa, Honduras	-6	No		
41	Phoenix, Arizona	-7	No		
42	Denver, Mountain Time	-7	Yes	2 nd Sun. Mar. (02:00)	1 st Sun. Nov. (02:00)
43	Los Angeles, Pacific Time	-8	Yes	2 nd Sun. Mar. (02:00)	1 st Sun. Nov. (02:00)
44	Anchorage, Alaska (US)	-9	Yes	2 nd Sun. Mar. (02:00)	1 st Sun. Nov. (02:00)
45	Honolulu, Hawaii (US)	-10	No		
46	Midway Islands (US)	-11	No		
47	Mexico City, Mexico	-6	Yes	1 st Sun. Apr. (02:00)	Last Sun. Oct. (02:00)
48	Adak (Aleutian Is.)	-10	Yes	2 nd Sun. Mar. (02:00)	1 st Sun. Nov. (02:00)
49	UTC (GMT)	0	No		
50	UTC (GMT)	0	No		
51	UTC (GMT)	0	No		
52	UTC (GMT)	0	No		
53	UTC (GMT)	0	No		
54	Ittoqqortoormiit, Greenland	-1	Yes	Last Sun. Mar. (00:00)	Last Sun. Oct. (01:00)
55	Nuuk, Qaanaaq, Greenland	-3	Yes	Last Sat. Mar. (22:00)	Last Sat. Oct. (23:00)
56	Not used				
57	Western Australia: Perth	+8	No		
58	Caracas	-4.5	No		
59	CET standard time	+1	No		
60	Not used				
61	Not used				
62	Baku	+4	Yes	Last Sun. Mar. (04:00)	Last Sun. Oct. (05:00)
63	UTC (GMT)	0	No		
64	UTC (GMT)	0	No		

In countries where the DST switch date changes annually (e.g. Iran, Israel), the time zone has to be defined manually in the user time zone table (entries 80 – 99).

Legend:

UTC: Universal Time Coordinate, equivalent to GMT
DST: Daylight Saving Time
DST Change: Daylight Saving Time changeover
Standard → DST: Time change from Standard time (Winter time) to Summer time
DST → Standard: Time change from Summer time to Standard time (Winter time)

Example:

2nd last Sun. Mar. (02:00) Switch over on the penultimate Sunday in March at 02.00 hours local time.



Important:

The Time Zone Table is usually updated as needed. The current table is available for download under the following address: www.mobatime.com → Customer Area → Customer Support → Support Resources → Time Zone Table. In case your device is equipped with a newer version than shown in this manual, the current time zone settings should be checked.

Modifications / updating the time zone table:

The time zone tables are filed in the */etc/mbsn.tbl* (standard table) and */etc/usersn.tbl* (user table) files.

The user table can be changed with Moser-Baer AG software MOBA-NMS.

Using MOBA-NMS, it can be downloaded from there, otherwise, it must be copied on to the DTS 4160 in accordance with the update instructions (chapter “7.3 Updating applications or configurations with FTP”).



Notice:

The file names *mbsn.tbl* and *usersn.tbl* must be written in small letters.

C Alarm list

Nr.	Error message	Description	Action	Chap.
0	Reboot DTS	DTS 4160 restarted	➔ no intervention required	
1	System warning	Internal System Warning	Check dts.log for detail Warning information	
2	Supply voltage too low	Power failure (internally measured)	➔ support	
3	Failure red. supply	Power failure redundant supply (only if redundant supply is on)	➔ Check in the menu which power supply fails	
4	Internal voltage to low	Power failure (internally measured)	➔ support	
5	To high offset to GNSS	To high offset to GNSS	➔ check GNSS time source	
6	To high offset to PTP	To high offset to PTP	➔ check PTP time source	
7	To high offset to DCF	To high offset to DCF	➔ check DCF time source	
8*	Too high offset to FREQ	To high offset to Frequency-In	➔ check FREQ time source	
9*	Too high offset to E1	To high offset to E1	➔ check E1 time source	
10	PTP synch lost		➔ check PTP time source	
11	DCF synch lost		➔ check DCF time source	
12*	FREQ synch lost		➔ check FREQ time source	
13*	E1 synch lost		➔ check E1 time source	
14	Lost GNSS time source	Bad GNSS reception quality	➔ check GNSS Antenna installation ➔ check GNSS Configuration	A.3 6.5.15
15	Time source big offset	Big offset to time source detected	➔ check time source	
16	Time source fail stratum	Stratum too high	➔ check time source	
17	Failure time source TO	No time information from the selected time source within the configured timeout	➔ check time source ➔ In slave mode: check link	6.5.9, 6.5.10
18	No valid time	20 min after starting no valid time	➔ Check time source	6.5.9
19**	NTP synch lost		➔ Check NTP configuration	
20**	Too high offset to NTP		➔ Check NTP time source	
21	NTP failed	NTP not running	➔ Check NTP configuration	
22	Error bit 22	Not used		
23	No valid time source		➔ Check synchronization and source settings	6.5.10
24	No mail server	No connection to configured mail server	➔ Check e-mail configuration, check connection	6.5.22
25	SNMP Error	SNMP not running	➔ Check SNMP and trap configuration	6.5.23
26	Error bit26	Not used		
27	Error bit27	Not used		
28	Error bit28	Not used		
29	NTP Configuration Error	Configured NTP Authentication Key is not correct	➔Check the configured NTP trusted keys against imported key file. ➔Check the configured keys for multicast against configured trusted keys ➔see dts.log file for details	6.5.13
30	Error bit 30	Not used		
31	No DTS link (optical)	No connection via optical link in redundant operation.	➔ Check redundant link connection.	
32	Change Slave->Master	Switch over slave -> master has occurred.	➔ Optionally, check the time source of current slave.	
33	Too high offset to Master	In redundant slave mode only:	➔ check time sources	6.5.11, 6.5.9

		Slave too high offset to master		
34	Oscillator not locked	During start-up / first time synch: During normal operation:	➔ normal behaviour, no action ➔ support	Oscillator not locked
35	SyncE not running			
36	PTP not running	PTP not running	➔ Check PTP configuration	6.5.14
37	Error bit37	Not used		
38*	serial line1 Tele.-file invalid	Invalid telegram file selected	➔ Check telegram file: The file name is longer than 8 digits or the file type is not TEL, Tel or tel; alternatively, syntax error in telegram file	6.5.4
39*	serial line1 Wrong time zone	Invalid time zone configured	➔ Check serial time zone configuration	
40*	serial line2 Tele.-file invalid	➔ See alarm bit 38	➔ See alarm bit 38	
41*	serial line2 Wrong time zone	➔ See alarm bit 39	➔ See alarm bit 39	
42	Error bit42	Not used		
43	Error bit43	Not used		
44	Error bit44	Not used		
45	Error bit45	Not used		
46	Error bit46	Not used		
47	Error bit47	Not used		
48	Error bit48	Not used		
49	Error bit49	Not used		
50	Error bit50	Not used		
51	Error bit51	Not used		
52	Error bit52	Not used		
53	Error bit53	Not used		
54	DCF1 Wrong time zone	Invalid time zone configured	➔ Check DCF configuration	6.5.2
55	Error bit55	Not used		
56	Error bit56	Not used		
57	Error bit57	Not used		
58	Wrong time zone DCF-IN	Invalid time zone configured	➔ Check DCF configuration	
59*	Wrong time zone TC1	Invalid time zone configured		
60*	Wrong time zone TC2	Invalid time zone configured		
61	Error bit61	Not used		
62	Error bit62	Not used		
63	Error bit63	Not used		

* **Only applicable for DTS 4160**

** **Only applicable for DTS 4150**

D Troubleshooting

	Error	→	→	Solution / possible cause
1	DTS 4160 is restarting continuously.			Check if the network settings are correct, especially the hostname and the gateway has to be configured (when no gateway is available, the own IP address can be used).
2	LAN LED (left one) is off.	No connection to the network.		Check network cabling.
3	Opening the menu via SSH is not possible or DTS 4160. Grandmaster is not or no longer reachable via network.			Check network settings in menu 2 Configuration → 5 Network (only possible with serial connection): - IP-Address, Subnet mask and Gateway must be set correctly - Interface should be set to Auto - Check connection with "Ping" - When earlier the menu was not correctly exited (e.g. LAN cable removed), the menu can be blocked up to 15 minutes.
4	Drift (ppm) of quartz too high	The drift displayed in the menu <i>Status</i> → <i>Time</i> → TIME INFORMATION AND STATUS is bigger than stated in the data sheet.		<ul style="list-style-type: none"> The quartz drift is measured and corrected continuously. After initial operation, it may take up to 7 days until optimal accuracy is reached (with GPS reception). Time correction was carried out manually.
5	System software update			The system software can be updated using FTP client software or a USB stick (s. chapter 7 Updates). Your MOBATIME service informs you of use and necessity of a software update. If necessary, they can provide the needed firmware file.
6	Needed information to contact your MOBATIME service			<p>Device type, part number, production number and serial number:</p> <p>These details are given on the adhesive type label.</p> <p>If possible provide the following files for the analysis:</p> <p>All files from the directories <i>/var/log/</i> and <i>/etc/</i> and the file: <i>/ram/trim.log</i>. To copy this files use FTP, e.g. Windows Explorer with ftp://dts@[IP address], see chapter 7.6.</p> <p>If the log files cannot be copied, please read out the current software version:</p> <p>The software version can be queried in the menu 1 STATUS/9 Versions of the software</p> <p>Place and date of purchase and of commissioning of the device.</p> <p>Most comprehensive possible details of the malfunction:</p> <p>Describe the problem, possible causes, measures taken, the system environment / operating mode and configuration, etc.</p>

E Serial Telegrams (*only DTS 4160*)

E.1 General

A serial interface can be used in two different modes:

- Send out time of telegrams automatically (periodically)
- Receive command, send time telegram (on request)

Output modes

Auto Periodic transmission of a time telegram or a command at the end of a second, minute, hour, or at a max. of 6 programmable times of the day, or definable output – periodicity.

on request Telegram is transmitted on request. The 'request' strings can be defined.

The following requests are possible:

- stop output
- output telegram at once (singly)
- output telegram at the next second (singly)
- output every second / minute / hourly / daily or switch to auto-mode.

Telegram format

Any character sequence. Fill characters ASCII or binary.

Variable display: ASCII decimal, ASCII hexadecimal or binary. Different variables are assigned to strings in text tables (e.g. month: Jan, Feb...). Syntax for the telegram string analogous to the print command in the programming language "C". See chapter E.2 Syntax of the telegram configuration file.

Telegram time

The telegram always contains the time information for the "next" second for periodical telegram output. The telegram content is valid at the send time of the first character. The send time of the telegram can be shifted with the parameter TC (e.g. the standard IF 482 telegram valid at the end of the telegram).

The transmission time of a time telegram can be calculated with the following table. According to the transmission format set, the transmission time in ms for one character is read from the table and multiplied by the number of telegram characters:

parity stop byte	7 data bits				8 data bits				
	none		odd/even		none		odd/even		
	1	2	1	2	1	2	1	2	
ms per transmited byte									
300	bit/s	30.00	33.33	33.33	36.67	33.33	36.67	36.67	40.00
600	bit/s	15.00	16.67	16.67	18.33	16.67	18.33	18.33	20.00
1200	bit/s	7.50	8.33	8.33	9.17	8.33	9.17	9.17	10.00
2400	bit/s	3.75	4.17	4.17	4.58	4.17	4.58	4.58	5.00
4800	bit/s	1.88	2.08	2.08	2.29	2.08	2.29	2.29	2.50
9600	bit/s	0.94	1.04	1.04	1.15	1.04	1.15	1.15	1.25
19200	bit/s	0.47	0.52	0.52	0.57	0.52	0.57	0.57	0.63
38400	bit/s	0.23	0.26	0.26	0.29	0.26	0.29	0.29	0.31

Example:

9600 Bit/s, 8 data bits, none, 1 stop bit, the telegram has 20 characters.
Transmission time for the entire telegram:
20 x 1.04 ms = 20.8 ms

Name of the telegram file

The telegram file name is limited to 8 characters and its extension has to be TEL, Tel or tel, e.g. IF482Std.tel.

E.2 Syntax of the telegram configuration file

```
!TEL
    ;telegram type also !CTC or !MTS possible
;-- Start of the file (always on the first line) -----

;DEFINITIONS CONFIGURATION FILE FOR PRECISION MASTER CLOCK
;*****

;Customer:
;Date:
;Author:
;File:
;Interface:

;-- Output string -----
; the output string has a similar format to the print command in the
; programming language 'C'.
; !TS! - String with format information
; !TV! - Variables list in output sequence
; The formats and variables available can be seen below:
;
!TS!".....%d....%d..." ;String with Format information
!TV!var1,var2,..         ;Variables list

;-- Control and special characters
; " -> String beginning/end
; \" -> "
; \xFE -> h'FE (Byte binary)
; \\ -> \
; \n -> new line <CR> <LF> (h'0D h'0A)
; %% -> %
; %... -> Format information (see below)

;-- Possible formats:
;%dn ascii-dez where n=1/2/3/4 (number of decimal points, max. 3 places received)
; e.g. variable value d'40 => 40 @ n=2
; e.g. variable value d'40 => 040 @ n=3
;%X ascii-hex
; e.g. variable value d'40 => 28
;%c char (binary)
; e.g. variable value d'40 => h'28
;%s string (always up to,(comma) see text tables
; e.g. string Jan, => Jan
;%b hex-output of an asciihex-string (always up to,(comma)see
; text tables
; e.g. string 120A, => h'12 h'0A

;-- Possible variables:
;
;Name: Description: Range: Format:
;-----|-----|-----|-----
;
;MSE (Millisecond) (0..999) 1W
;HSE (Hundredth of a second) (0..99) 1B
;ZSE (Tenth of a second) (0..9) 1B
;SEK (Second) (0..59) 1B
;MIN (Minute) (0..59) 1B
;STD (12h or 24h format) (0..12)
; or(0..24) 1B (see !PM!)
;JAR (Year) (0..99) 1W
; or (1990..2089)
```

```

;MTG (Day of the month) (1..31) 1B
;JTG (Day of the year) (1..366) 1W
;WTG (Day of the week) (0..6) 1W Text table !WT!
;
;(Su..Sa)
;DOW (Day of the week) (0..7) 1B !DW!
;KAW (Calendar week) (1..53) 1B (according to Din ISO 8601)
;MON (Month) (1..12) 1W Text table !MO!
;MNT (Month) (1..12) 1B
;
;AMF (am/pm flag) (0/1) 1W Text table !AM!
;TMQ (synchronization qual.) (0..255
; or A..Z) 1B (see !TQ!)
;SAI (Season) (0..2) 1W Text table !SA!
;
;(Win/Sum/UTC)
;AKS (Season change (0/1) 1W Text table !AK!
; announcement)
;SST (Season status) (0..3) 1W Text table !ST!
;
;(Bit 0 = Early warning bit)
;(Bit 1 = Summer bit)
;SYA (Synch. alarm) (0/1) 1W Texttable !SY!
;
;(0:synch ok, 1: synch alarm -> Alarm Nr.16, 17 or 19)
;CHS (Check sum) (0..255) 1B
;XCH (XOR Check sum) (0..255) 1B
;X1C (XOR Check sum low nibble in ASCII) (0..9, A..F) 1B
;X2C (XOR Check sum high nibble in ASCII) (0..9, A..F) 1B
;
; Definitions:
; CHS = (Sum of all bytes up to CHS) AND h'FF
; XCH = XOR link of all bytes up to CHS

;e.g. time telegram with following format (36 ASCII characters)
;
;"Date: tt:mm:yy Time: hh:mm:ss,mmm<CR><LF>"
;
;!TS!"Date: %d2:%s:%d2 time: %d2:%d2:%d2,%d3\n"
;!TV!MTG,MON,JAR,STD,MIN,SEK,MSE
;-----

;-- Send offset automatic telegram output -----
!SO!hh:mm:ss!
;
;Send offset from midnight 00:00:00 at periodic time
;output (!CS!a!...).
;
;hh = hour ('00..23')
;mm = minute ('00..59')
;ss = second ('00..59')
;
;e.g. the periodic time output should start at 06:00:00
; in each case:
;
;!SO!06:00:00!
;
;-----

;-- Interval automatic telegram output -----
!TI!p!hh:mm:ss!
;
;Interval from send offset of the periodic time output.
;
;s = every second
;m = every minute
;h = hourly
;d!hh:mm:ss! daily (max. 6 entries)
;p!hh:mm:ss! constant
;hh = hour ('00..23')
;mm = minute ('00..59')
;ss = second ('00..59')
;
;e.g.1 telegram output every second
; !TI!s!
;
;e.g.2 telegram output daily at 13:00:00 hours
; !TI!d!13:00:00!
;
;e.g.3: the interval of the periodic time output should be 5 seconds:
; !TI!p!00:00:05!
;-----

```

```

;-- Hours format -----
!PM!
    ;Hours format 12h with am/pm flag
    ;without this entry: 24h format
;-----

;-- Synchronization mode -----
!TC!mmm!
    ;Pretiming of the telegram in ms (-90..249). To synchronize the telegram
    ;end with the second start the TC has to be set according to the telegram
    ;length and the transmission format. If TC is set, it will be performed.
    ;
    ;e.g. Telegram start 120ms before the start of the second:
    ;     !TC!120!
;-----

;-- Format time quality -----
!TQ!MAX VALUE!STEP!
    ;If this entry is absent, the byte value of TMQ is
    ;outputted
    ;MAX VALUE corresponds to the byte value for A
    ;MAX VALUE-STAGE corresponds to the byte value for B
    ;MAX VALUE-2*STAGE corresponds to the byte value for C ...

    ;Example: A for values >=120..101
    ;          B for values =100..81
    ;          C for values = 80..61 ...
    ;
    ;          !TQ!120!20!
;-----

;-- Command Strings -----
!CS!n!l!"ss..."! or !CS!n!l!"ss..."!
;
;n = Number of the command ('2...9')
;n=2 Quit (no telegram output)
;n=3 Telegram output immediately(singly)
;n=4 Telegram output at the next second(singly)
;n=5 Telegram every second
;n=6 Telegram every minute
;n=7 Telegram hourly
;n=8 Telegram daily (-> entry: !TI!d!xx..)
;n=9 Output command (Request for external time source)
;n=a Telegram output periodic according to !TI!p! and !SO!
;
;l or l1 = Command length in bytes ('01...20')
;l=0 Command not active
;
;ss... Command string
;      (max. 20 characters - must conform with 'l' or 'l1')
;      Wildcards can be set with the '?' sign.
;      This serves as wildcard for any character.
;      Characters can also be outputted in AsciiHex format:
;      e.g.  \xFE    d.h <FE>=(h'FE) is inserted
;           \\      d.h '\ ' is inserted

;e.g. Definition of a commando for immediate telegram
;      output after a request (command n=3) :
;      'time<CR>' (characters l1=05)
;      !CS!3!05!"time?"!
;      !CS!3!5!"time\x0D"!
;-----

;-- Area for check sum calculation-----
!CK!aa,bb!
    ;aa = first character considered (telegram start position: 0)
    ;bb = last character considered + 1

;Missing !CK! in this case the check sum is formed via the whole telegram up to the
;check sum position.
;-----

```

```

;=====
;General info about the text tables:
; Name of the table:          !xx!
; Separating character of the entries:  , (comma)
; Maximal 16 characters pro Entry
; Warning:          , do not forget (comma) after the last entry!
;=====

;-- Text table day of the week (WTG Su..Sa) 7 entries -----
!WT!Sunday,Monday,Tuesday,Wednesday,Thursday,Friday,Saturday,
;-----

;-- Weekday modus 1 entry -----
!DW!0..3
           ; 0 : 0 = Sunday, 1 = Monday,... 6 = Saturday
           ; 1 : 1 = Sunday, 2 = Monday,... 7 = Saturday
           ; 2 : 6 = Sunday, 0 = Monday,... 5 = Saturday
           ; 3 : 7 = Sunday, 1 = Monday,... 6 = Saturday
;-----

;-- Text table months (Jan..Dec) 12 entries -----
!MO!Jan, Feb, Mar, Apr, May, Jun, Jul, Aug, Sep, Oct, Nov, Dec,
;-----

;-- Text table season (Win, Sum, UTC) 3 entries -----
!SA!Win, Som, UTC,
;-----

;-- Text table season change announcement -----
;-- (no announcement, announcement) 2 entries
!AK!0,1,
;-----

;-- Text table season status -----
;-- (0 = no announcement, winter
;-- 1 = announcement, winter
;-- 2 = no announcement, summer
;-- 3 = announcement, summer) 4 entries
!ST!A,B,C,D,
;-----

;-- Text table AM/PM flag 2 entries -----
!AM!am, pm,
           ;1.Entry  AM/PM flag=0 d.h. 00:00..11:59
           ;2.Entry  AM/PM flag=1 d.h. 12:00..23:59
;-----

;-- Text table synchronization alarm 2 entries -----
!SY!ok, alarm,
           ;1.Entry  synchronization ok
           ;2.Entry  synchronization s-failure
;-----

;-- File End ---
!EE!

;-- Name of the file (optional) ----
@nnn...
           ;nnn... File name, maximum 12 characters and a final
           ;          <CR>. The name can also be omitted, in this
           ;          case CTC 'NONAMEX.TEL' appears in the directory.
           ;
           ;IMPORTANT:
           ;          1) The name must stand AFTER the file end!EE!.
           ;
           ;          2) If a file with the same name is loaded on to the
           ;          CTC, such as one stored on the CTC, the stored one
           ;          will be OVERWRITTEN.
           ;
           ;
           ;e.g.      !EE!
           ;          @TELEDEF.TEL
           ;          ;last line
;-----

;last line (guarantees a <CR> after the file name)

```

F Copyright Notice

All rights of the software remain the property of Moser-Baer AG.

Existing software (OpenSource) with their own licences were partly used:

Designation	Description	Version	License	License Description (file)
U-Boot	Boot loader	2013.04	GPL version 2	COPYING
Linux	Operating system	4.14.0	GPL version 2	COPYING
Busybox	System environment	1.30.1	GPL version 2	LICENSE
NTP	NTP	4.2.8p13	Free	COPYRIGHT
PTP4I	PTP	2.0	GPL version 2	COPYING
pure-ftp	FTP server	1.0.48	Free, partly BSD	COPYING
NetSNMP	SNMP agent	5.7.3	BSD	COPYING
OpenSSL	SSL Lib.	1.1.1a	BSD style	LICENSE
OpenSSH	SFTP server	7.9p1	BSD	LICENCE
dropbear	SSH server	2019.78	MIT style: Free, party BSD	LICENSE
wide-dhcpv6	DHCPv6 client	20080615	Free	COPYRIGHT
zlib	Compress lib.	1.2.11	Free	README
mailsend	E-mail client	1.18	GPL	COPYRIGHT

The complete license descriptions can be referred to in the file indicated in the respective original source code on the corresponding project page.

Licence text GPL, BSD and MIT:

GPL version 2: <http://www.gnu.org/licenses/gpl-2.0.html>

BSD: <http://www.opensource.org/licenses/bsd-license.php>

MIT <http://www.opensource.org/licenses/with-license.php>

The source code of the open source projects running under GPL can be requested from Moser-Baer AG (support@mobatime.com). Handling costs will be charged!

G Technical data

Dimensions	19" Rack, 1HU x 28PU (H x W x D [mm]) = 44.5 x 483 x 190	
Weight	DTS 4160: approx. 2.3 kg;	DTS 4150: approx. 1.9 kg
Ambient temperature	0 to 50°C, 10-90% relative humidity, without condensation Equipped with 1 cooling fan.	
MTBF	> 250'000 h (Rubidium Oscillator > 150'000 h)	
Expected lifetime	> 10 years, typical > 15 years	
Operation	Telnet / SSH / MOBA-NMS (via LAN). In addition, operation is also possible with SNMP.	
Accuracy	"GPS" means: GPS RF input	
Internal accuracy:	GPS to internal time:	typ. < +/- 30ns
	Redundant Link to internal time	typ. < +/- 50ns
	PTP to internal time	typ. < +/- 200ns
	DCF to internal time	typ. < +/- 200ns (after comp. fix offset)
	E1 to internal time	typ. < +/- 200ns (frequency only)
Source to output:	GPS to NTP:	typ. < +/- 100 µs
	GPS to PTP:	typ. < +/- 0.250 µs
	GPS to DCF:	typ. < +/- 5 µs
	GPS to Pulse:	typ. < +/- 5 µs
	GPS to IRIG analog:	typ. < +/- 200 µs
	GPS to IRIG digital:	typ. < +/- 1 µs
	GPS to Pulse/ Freq. BNC:	typ. < +/- 200 ns
	GPS to Pulse/ Freq. CL and RS422:	typ. < +/- 10 µs
	GPS to serial output:	typ. < +/- 10 ms (jitter < 10ms)
	GPS to SyncE:	G.811, G.812, G.813 compatible
	GPS to E1:	G.811, G.812, G.813 compatible (depending on used oscillator)



Notice: NTP reception (DTS 4160 as server to external NTP clients) can be influenced by the network traffic load and network devices (Hub, Switch, Router, Firewall...).

If many clients request simultaneously, the typical accuracy may not be reached.

DTS 4150 (TCXO):

Holdover (free run, never synchronized): < +/- 250 ms / day (2.5ppm) @ constant temperature

Holdover (GNSS sync > 24h)
< +/- 1 ms / day (0.1ppm) @ constant temperature
< +/- 10 ms / day (0.1ppm) @ 20°C +/-5°C

Device Compliances (**only applicable for DTS 4160**):

DTS 4160	Type A	Type B	Type C
ITU-T requirements	G.813	G.812	G.811
Wander specifications sync > 30d	< ±8.5 us/d < ±60 us/7d < ±255 us/30d < ±3.1 ms/y	< ±1.4 us/d < ±9.8 us/7d < ±42 us/30d < ±0.51 ms/y	< ±1.0 us/d < ±7 us/7d < ±30 us/30d < ±0.36 ms/y
Compliance statement*	Partial (<7d, 6σ ≈ 99%)	Partial (<7d, 2σ ≈ 68%)	Partial (<7d, 4σ ≈ 95%)

*Device compliances are based on statistical measures. 100% compliance cannot be guaranteed. The σ/% values indicate how many percent of the devices under test probably pass a compliance test over the specified time span presented in days (d). σ is a statistical estimate based on measurements conducted with a few devices.

Oscillator specifications (**only applicable for DTS 4160**):

DTS 4160	Type A		Type B	Type C
	≥ Revision 08	≤ Revision 07		
Oscillator type	OCXO		OCXO	Rubidium
Short-term accuracy (ADEV)	1e-11 @ t=1s	5e-12 @ t=1s	5e-12 @ t=1s	3e-11 @ t=1s
Phase noise	< -95 dBc/Hz @ 1Hz < -125 dBc/Hz @ 10Hz < -145 dBc/Hz @ 100Hz < -150 dBc/Hz @ 1000Hz		< -95 dBc/Hz @ 1Hz < -125 dBc/Hz @ 10Hz < -135 dBc/Hz @ 100Hz < -140 dBc/Hz @ 1kHz	< -70 dBc/Hz @ 1Hz < -87 dBc/Hz @ 10Hz < -114 dBc/Hz @ 100Hz < -130 dBc/Hz @ 1kHz
Free-run time deviation* never synchronized	< ±8.7 ms/d < ±61ms/7d < ±267 ms/30d < ±4.3 s/y	< ±8.8 ms/d < ±66 ms/7d < ±365 ms/30d < ±17 s/y	< ±2.2 ms/d < ±16 ms/7d < ±80 ms/30d < ±2.9 s/y	< ±5.7 us/d < ±85 us/7d < ±1.2 ms/30d < ±142 ms/y
Holdover time deviation* GNSS sync < 1h	< ±442 us/d < ±3.5 ms/7d < ±21 ms/30d < ±1.3 s/y	< ±540 us/d < ±8.4 ms/7d < ±110 ms/30d < ±15 s/y	< ±280 us/d < ±2.7 ms/7d < ±23 ms/30d < ±2.2 s/y	< ±3.8 us/d < ±72 us/7d < ±1.1 ms/30d < ±142 ms/y
Holdover time deviation* GNSS sync > 24h	< ± 53us/d < ± 740 us/7d < ±9.1 ms/30d < ±1.14 s/y	< ±152 us/d < ±5.6 ms/7d < ±99 ms/30d < ±14 s/y	< ±43 us/d < ±980 us/7d < ±16 ms/30d < ±2.2 s/y	< ±2.4 us/d < ±62 us/7d < ±1.1 ms/30d < ±140 ms/y
Holdover time deviation* GNSS sync > 30d	< ± 5.3us/d < ± 41 us/7d < ±233 us/30d < ±14 ms/y	< ±5.9 us/d < ±87 us/7d < ±1.2 ms/30d < ±143 ms/y	< ±3.2 us/d < ±30 us/7d < ±238 us/30d < ±23 ms/y	< ±0.9 us/d < ±11 us/7d < ±120 us/30d < ±15 ms/y
Aging	±2.0e-10/d ±1.0e-7/y	±3.0e-10/d ±2.0e-8/y	±1e-10/d ±1.5e-8/y	±2.5e-11/d ±1.0e-9/y
Temperatur drift holdover	±2e-10 (-20 ... +70°C)	±5e-9 (-10 ... +60°C)	±6E-10 (-20 ... +70°C)	±1.5E-10 (-10 ... +75°C)

*Holdover time deviations are worst case estimates based on measurements conducted in a stable environment (temperature of 22±3°C and stable humidity).

DTS 4150 and DTS 4160:

	Typical time till internal time base stable:	1 h
Redundant operation	Master to slave (optical DTS link):	typical < +/- 250 ns
Time server	NTP V4 SNTP PTP	(fully V3 compatible, RFC 1305), RFC 5905 (Port 123) (UDP), RFC 4330 (Port 123) (UDP), IEEE 1588-2019 (V2.1) (Ports 319 and 320)

	TIME	(TCP/UDP), RFC 868 (Port 37)	
	DAYTIME	(TCP/UDP), RFC 867 (Port 13)	
Max. number of NTP and SNTP client requests:	> 10'000 requests / sec. per device (e.g. client request every 60 sec. → 600'000 clients)		
NTP mode	Server, Peer, Broadcast, Multicast		
NTP slave clock lines:	Up to 4 lines with up to 15 different time zone entries. Communication through multicast: -RFC 3376: Internet Group Management Protocol, Version 3 -RFC 1112: Host extensions for IP multicasting -RFC 4601: Protocol Independent Multicast - Sparse Mode (PIM-SM) -RFC 3973: Protocol Independent Multicast - Dense Mode (PIM-DM)		
Time zones (see App. B)	Up to 80 predefined, 20 programmable entries (MOBA-NMS)		
PTP	-Standard: IEEE 1588-2019 (V2.1, no V1) -P2P, E2E -IPv4, IPv6, Layer2, UDP, multicast and unicast according to definition IEEE 1588 -Master or Slave (only Multicast) -1-step and 2-step mode -availability of management messages limited: requests only -profile: default (E2E & P2P), utility (IEC/IEEE 61850-9-3), ITU-T G.8265.1, ITU-T G.8275.1, ITU-T G8275.2, IEEE 802.1AS -no specific PTP SNMP MIB		
VLAN	LAN ports 1 to 4: 802.1Q (tagged VLAN) and 802.1p (prioritized VLAN) 2 VLANs per port can be defined (max. 8 VLANs)		
LAG	Available for LAN ports 2 / 3: 802.3ad (only port 2 has to be configured)		
3 Network interfaces	100/1000BaseT Data transmission rate: Auto-negotiation / manual Connection: RJ-45 Only shielded cables permitted.		
1 Network interface	100/1000Base-T(X) or FX Data transmission rate: Auto-negotiation / manual Connection: SFP for miniGBIC module		
IP Configuration	DHCP, Static IP, IPv4, IPv6		
Network services	NTP	UDP, Port 123	see timeserver
	SNTP	UDP, Port 123	see timeserver
	PTP	UDP, Port 319 and 320	see timeserver
	TIME	TCP/UDP, Port 37	see timeserver
	DAYTIME	TCP/UDP, Port 13	see timeserver
	Telnet	TCP, Port 23	operation
	SSH	TCP, Port 22	operation
	SCP	über SSH	update
	SFTP	über SSH	update
	FTP	TCP, Port 21	update
	SNMP	UDP, Port 161	operation
		UDP, Port selectable (162)	alarm notification, see SNMP
	SMTP	TCP, Port selectable (25)	alarm mail see E-Mail
	DHCP	UDP, Port 68	dyn. address allocation (client)
	DNS	TCP/UDP, Port 53	address resolution (client)
	DHCPv6	only IPV6	
	ECHO	ICMP	“Ping“

SNMP	V1, V2c, V3 with MD5 for authentication and DES for encryption (privacy).
E-mail	Alarm reporting via SMTP. Authentication at the mail server: - with sender address - with username/password SMTP-Auth with LOGIN, PLAIN (RFC 4954) or CRAM-MD5 (RFC 2195), no "POP before SMTP" possible
Receivers / antennas	DTS 4150: GPS-Module with GPS, Glonass, Galileo, Beidou included DTS 4160: GPS-Module with GPS, Glonass included External GPS-Antenna (PCTel or Tallysman) connected to GPS RF input
Time signal outputs	NTP V4 for slave clocks (unicast and multicast) 1 x DCF current loop interface passive
DCF output	DCF time code, time zone selectable Max. time deviation with GPS source: +/- 10 µs, jitter < 10 µs DCF time code passive current interface: V _{max} = 30 VDC, I _{on} = 10..15 am, I _{off} < 0.1 mA @20VDC

Only applicable for DTS 4160:

Time signal outputs	1 x IRIG-B output (analog and digital) 1 x Pulse / frequency output over RS 422, opto-coupler (current loop passive) 2 x Pulse / frequency output, BNC 50Ohm 2 x Script files configurable time telegrams on RS 232, RS 422 (only send) and RS 485 1 x E1 signal output over BNC (unbalanced) and RJ48 (balanced)
Pulse / frequency output	1 output for technical impulses: 10MHz, 2048kHz, 2Hz or 1 PPS (Pulse per second) possible 3 different electrical outputs with the same signal: - passive current loop output, opto-coupler: I _{max} =10 mA / U _{max} =50 VDC - RS422 output - BNC connector 50 Ohms (no load: 5 V, with 50 Ohms load: 2.5 V)
10MHz output	1 outputs for technical impulses, BNC connector 50 Ohms 10MHz, 2048kHz, 2Hz or 1 PPS (Pulse per second) possible (no load: 5 V, with 50 Ohms load: 2.5 V)
IRIG-B output	1 high precision IRIG output, available as analog and digital signals. Accuracy of the signal according to standard: DC level pulse rise time between the 10% and 90% amplitude points: ≤ 1 µs Jitter modulated at carrier frequency: ≤ 1% DC level jitter pulse-to-pulse: ≤ 200 ns Line mode: IRIG-B122, IRIG-B Std 12h (B122), IRIG-E122 DIEM, IRIG-B123, IRIG-B DIEM, AFNOR A, AFNOR C, DCF-FSK, IRIG-B126 (127), IRIG-B002, IRIG-B003, IRIG-B006 (007) IRIG analog: output voltage level (R _L =50 Ohm): 0.1 – 4 V _{pp} (configurable) SNR _{dB} : typical >= 40dB Impedance: R _i < 50 Ω IRIG digital: 50 Ω / 5V TTL driver output
Serial interfaces (2x) (back side)	2 lines for telegram output, RS232 or RS485 300-38400 Bauds, 7 or 8 Data bits, Parity: no, even, odd,

H DTS4160.grandmaster i

In this chapter all differences between the DTS4160.grandmaster and the DTS4160.grandmaster i are explained.

Output

The DTS4160.grandmaster i is equipped with 4 E1 / 2.048 MHz outputs. These 4 outputs are shown in the Menu as 1 output, because the 4 outputs are sending out the same signal.

Oscillator

The DTS 4160.grandmaster i is available with two different types of internal oscillators:

- Rubidium : DTS 4160c.grandmaster i
The rubidium oscillator provides the ability to extend the hold-over period for operation compatible to the G.811 in case off a temporary loss off the time source.
- OCXO: DTS 4160a.grandmaster i
This oscillator provides the ability to extend the hold-over period for operation compatible to the G.813 in case off a temporary loss off the time source.

These two oscillators are disciplined to the time source available (such as GNSS, PTP, E1...).

During the start-up, the oscillator has to warm-up. In this warm-up time the oscillator is not stable enough. This is the reason why the device waits for the oscillator to lock/stabilize. This takes normally up to 10 minutes. In the worst case this can take up to 2 hours, but this is really rare.

For operation with E1 line, the rubidium oscillator is the recommended option.

I Index

A

Accuracy	122
Accuracy - holdover	86
Alarm configuration	54
Alarm list	113
Alarm mask	56
Alarm relay	55, 126
Alarm status	16
Authentication	58, 91
Autoconf – Ipv6	65
Autokey	92

B

Baudrate	31
Baudrate – PC connection	101
Boot time	17
Broadcast NTP	47

C

Cable – PC connection	101
CAN monitoring with MTC	45
Community (SNMP)	96
Configuration	28
Configuration – Backup	75
Configuration – Restore	75
Configuration – save	81
Connection table (to fill in)	131
Connections – alarm relay	102
Connections – front view	101
Connections – IRIG-B12x outputs	104
Connections – PC	101
Connections – rear view	102
Connectors	110
Control Key	45
Copyright	121
CRAM-MD5	58

D

Data bit	31
Daylight Saving Time	112
DAYTIME	124
DC power supply	100, 102, 126
DCF input	104, 105
DCF output	30, 104, 125
DCF settings	53
DES – Data Encryption Standard	91
DHCP	65
DHCPv6	65
Display	16
DST	112
DTS (Distributed Time System)	12
DTS Link	42, 94, 126

E

E1 output	93, 126
E1 settings	54
E1 signals	34

E-mail	57, 125
--------	---------

F

Factory settings	17, 75
F-IN settings	54
Firmware	16
Front connections	101
FTP	69, 80, 124

G

GBIC	126
GBIC Module	94
GNSS – Antenna	105, 106, 108
GNSS – EMP Protector	105, 109
GNSS – Inline Amplifier	106
GNSS settings	52

H

Holdover Accuracy	123
-------------------	-----

I

IEEE 1588	48, 124
Interface	116
IPv4 configuration	63, 65
IPv6 – FTP connection	80
IPv6 configuration	65
IRIG / AFNOR output	33
IRIG-B output	125

L

Language setting	61
Leap second	50
Leap second - correction	90
Leap second - PTP	89
Leap second handling	89
Leap second mode	41
LED description front side	14
LED description rear side	15
Lightning protection	105
Link aggregation LAG	66
Linux	18
Login (menu)	18

M

Mains power supply	100, 126
Maintenance	75
Manual time set	41, 86
MD5	91
Menu login	18
MIB files	96
mini GBIC	94, 126
MOBA-NMS	13, 18, 20, 77, 112
MTBF	122
Multicast	34, 124
Multicast address	42
Multicast NTP	47

N

network - security	7
Network configuration	62
Network ports	123
Network services	69, 124
Notification	97
NTP	124
NTP Access control for query (ntpq)	46
NTP authentication	45, 91
NTP Autokey	92
NTP broadcast	47
NTP mode	124
NTP multicast	47
NTP requests	124
NTP slave clocks	34, 124
NTP symmetric keys	91
NTP version	88
<i>ntp.keys</i>	45
ntpq	22

O

Operation (menu)	18
Operation (MOBA-NMS)	20
Operation (SNMP)	97
Oscillator	93, 127
Outputs	29, 125

P

Parity	31
Password	7, 18
Password configuration	61
PCP	68
ping	22
Power setting	61
Power supply	100
Problem solving	115
Program file	82
PTP	92, 93, 95, 124
PTP – Configuration	50
PTP – Mode	48
PTP – Profiles	48, 124
Pulse / frequency output	125

R

Redundant NTP Multicast time server	35
Redundant operation	42, 94
Request Key	45
Restart	17, 75
Routing table	22

S

SCP	81, 124
Script file definition	117
Serial connection	18
Serial interfaces	31, 125
Serial telegram file	31
Serial telegram file upload	32
Serial telegrams	116
SFTP	80, 124
SHA1	91
SMTP	124

SNMP	13, 96, 125
SNMP – alarm notification	99
SNMP – alive notification	99
SNMP – notification	97
SNMP – operation	97
SNMP access configuration	73
SNMP configuration	59, 70
SNMP traps	59, 97
SNMP user configuration	72
Sntp	124
Software update	77, 78
Software version	16
Spring terminals	110
SSH	18, 69, 124
Start-up	17
Static routing	63, 67
Status menu	21
Stop bit	31
Stratum	87
SyncE	93
Synchronization process	84

T

TAI	50
TAI Offset	23
Telegram – definition	117
Telegram file	75, 82, 116
Telnet	18, 69, 124
Terminal	18
TIME	124
Time acceptance	86
Time administration	83
Time handling	37
Time server	88, 123
Time source – configuration	38
Time source – priority	39
Time source information	25
Time zone for displayed time	61
Time zone selection	74
Time zone server	34, 36
Time zone table	111
Time-keeping	40
Transmission time	116
Trap	59, 97
Troubleshooting	115
Trusted Key	45
ttl (time to live)	47

U

Update – software	77, 78
Update time zone table	112
USB	75, 78, 79, 82
USB configuration	61
USB stick	16
UTC	83, 112

V

Version	16
VLAN	124
VLAN configuration	68
VLAN ID	68

W

World time

34

*Headquarters/Production
Sales Worldwide*

MOSER-BAER AG | Spitalstrasse 7 | CH-3454 Sumiswald
Tel. +41 34 432 46 46 | Fax +41 34 432 46 99
moserbaer@mobatime.com | www.mobatime.com

Sales Switzerland

MOBATIME AG | Stettbachstrasse 5 | CH-8600 Dübendorf
Tel. +41 44 802 75 75 | Fax +41 44 802 75 65
info-d@mobatime.ch | www.mobatime.ch

MOBATIME SA | En Budron H 20 | CH-1052 Le Mont-sur-Lausanne
Tél. +41 21 654 33 50 | Fax +41 21 654 33 69
info-f@mobatime.ch | www.mobatime.ch

Sales Germany/Austria

BÜRK MOBATIME GmbH
Postfach 3760 | D-78026 VS-Schwenningen
Steinkirchring 46 | D-78056 VS-Schwenningen
Tel. +49 7720 8535 0 | Fax +49 7720 8535 11
buerk@buerk-mobatime.de | www.buerk-mobatime.de